

INNOVATIVE APPLICATION OF SMOKE CONTROL IN RESIDENTIAL CARE BUILDINGS: FIRE TESTS AND ANALYSIS

PROJECT no. VIPA/2019/64



STUDY PERFORMED BY

WFRGENT NV
OTTERGEMSESTEENWEG-ZUID 711
9000 GENT

warringtonfire
Proud to be part of 

IN ASSIGNMENT OF

HET VLAAMS INFRASTRUCTUURFONDS VOOR
PERSOONSgebonden AANGELEGENHEDEN (VIPA)
&
DEPARTEMENT ECONOMIE, WETENSCHAP & INNOVATIE (EWI)

 **Vlaanderen**
is zorgzaam samenleven

IN PARTNERSHIP WITH

 **etex** inspiring ways
of living

 **theuma**
doors & frames



 **BELGIAN FIRE
SPRINKLER NETWORK**

 **Kingspan**
Light - Air

 **Verenigde
Sprinkler Industrie**
verenigde-sprinkler-industrie.nl

 **LYBOVER**
ON THE MIND OF ENGINEERING
FIRE
Keller Benelux

 **EUROPEAN FIRE
SPRINKLER NETWORK**

CONTENTS

1	Introduction	5
1.1	First VIPA Study	5
1.2	Need for additional research	5
1.3	Objective of this study.....	7
1.4	Research methodology	7
1.5	Operation and composition of the steering committee	8
1.6	Operation and composition of the project group.....	9
1.7	Acknowledgements.....	10
2	Smoke control	11
2.1	Predetermined level of safety.....	11
2.2	Definition of 'Smoke Control'	12
2.3	Creation of a smoke-free evacuation route in the fire room.....	13
2.4	Preventing the spread of smoke (and the spread of other toxic gases) to adjacent compartments.....	16
2.5	Making the fire room (= evacuation route) smoke-free	18
2.6	Composition of smoke control system (= residential smoke control system).....	20
3	Test set-up of the large-scale fire tests.....	23
3.1	General test set-up.....	23
3.2	Fire source.....	26
3.3	Active fire safety measures	28
3.4	Passive fire safety measures	35
3.5	Measurements	36
3.6	Airtightness	39
4	Large-scale fire tests.....	41
4.1	Test 1: "Reference test"	41
4.2	Test 2: Application of a fire screen (up to 0.9 m above the ground)	50
4.3	Test 3: Application of a fire screen (completely down)	58
4.4	Test 4: Application of an adjustable smoke control system	67
4.5	Test 5: Application of automatic extinguishing.....	77
5	Additional CFD simulations	89

5.1	Introduction.....	89
5.2	Smoke control system to prevent the spread of smoke	90
5.3	Smoke control system using a fire screen up to a height of max. 1 m.....	127
5.4	Clear separation between the smoke layer and the ambient air (= smoke-free height)....	135
6	Conclusions.....	140
6.1	Smoke control.....	140
6.2	Influence of the airtightness of the fire room on the spread of smoke.....	141
6.3	Evacuation through a fire room	142
6.4	Preventing the spread of smoke (and the spread of other toxic gases) to adjacent compartments.....	143
6.5	Making the fire room smoke-free	144
7	Sources	145
8	Annexes (Measurements during the large-scale fire tests)	146
8.1	Test 1: “Reference test”	146
8.2	Test 2: Application of a fire screen (up to 0.9 m above the ground)	149
8.3	Test 3: Application of a fire screen (completely down).....	153
8.4	Test 4: Application of an adjustable smoke control system.....	158
8.5	Test 5: Application of automatic extinguishing.....	163

1 INTRODUCTION

1.1 FIRST VIPA STUDY

In 2014, a study was commissioned by the “Vlaams Infrastructuurfonds voor Persoonsgebonden Aangelegenheden (VIPA)” with the topic “Brandveiligheid in ouderenvoorzieningen: Onderzoek naar de doelmatigheid van alternatieve brandveiligheidsmaatregelen bij nieuwe zorgconcepten” ([link website](#) [1]).

This first VIPA study was carried out by WFRGent nv and Ghent University and aimed to investigate the influence of active and passive fire safety measures on the spread of smoke in the event of a fire in a common area that is open to the evacuation route. After all, the current regulations require a fire resistant separation between the common area and the evacuation route.

Based on the results of large-scale tests, supplemented by additional CFD simulations (CFD: Computational Fluid Dynamics), the fire safety measures were proposed in function of the location of the individual rooms and the evacuation strategy (which is either an (immediate) evacuation from the room or a “Defend in Place”). Rooms giving out on the common area as well as rooms giving out on a fire compartmentalized evacuation route were investigated.

The study has resulted in the preparation of an assessment framework (see § 6.6 and § 7.4 in the aforementioned study [2]) based on the above-mentioned scientific research, which is used by the Flemish government as a basis for granting deviations from the legislation regarding elderly facilities.

1.2 NEED FOR ADDITIONAL RESEARCH

1.2.1 Fire safety needs of the healthcare sector

Following the (first) VIPA study, an additional study was carried out on behalf of the “Programma Innovatieve Overheidsopdrachten (PIO)” entitled “Beoordelingskader voor brandveiligheid in de zorgsector – Eindverslag Behoeftenanalyse”.

During this study, a needs analysis was carried out and it was clearly mapped out on which measures or technologies the various stakeholders (designers, operators of care centres, fire brigade,...) want to use the most in terms of fire safety, regardless of the existing regulations. The scores of various case studies were presented on the basis of an overview table, with a classification according to the type of occupant and type of building. In the conclusions of this, smoke control always scored high, because – according to this additional study – this is an important technology to make both evacuation strategies (immediate evacuation or “Defend in Place”) successful.

A second scoring category was used to evaluate the measures that would be preferred to be used more, but where there are doubts about the technical feasibility and affordability of the case studies. Here too, smoke control scored high.

This made it clear that there is a lot of interest in smoke control. Further research into the effectiveness of these measures would – according to this additional study – certainly be of great value.

1.2.2 “Defend in Place” strategy: always applicable?

After the completion of the first VIPA study, numerous lectures were given both in Flanders (Fire Forum Congres (Brussels - 24/11/2016), Info day VIPA (Leuven - 08/03/2017), PREBES PRENNE (Edegem - 21/09/2017) and BFSN study day (Asse - 12/10/2017)) and in the Netherlands (IFV Fire Safety & Science Congres (Arnhem - 08/11/2017 and 14/11/2018)) in which it could be established that there was a huge interest in the results and conclusions of this study.

One of the most frequently asked questions/comments during these lectures was how a "Defend in Place" strategy can be guaranteed, i.e. how can be guaranteed that a person will stay in his/her room for at least 15 to 20 minutes in the event of a fire (alarm) and that they will wait for the fire brigade to come and get him/her out. In addition to this, the fire room must be made smoke-free by the fire brigade or the evacuation must be done from the outside.

If this cannot be guaranteed, given the unpredictability of human behaviour in the event of a fire, an evacuation through the fire room is the only way to evacuate and a smoke-free evacuation route is therefore necessary.

The above question regarding the feasibility of a "Defend in Place" strategy was asked both in Flanders and in the Netherlands.

1.3 OBJECTIVE OF THIS STUDY

This (second) VIPA study should be seen as part of a large-scale study [3] in which a total fire safety concept of residential care buildings will be developed and this in function of the chosen evacuation strategy and of the type of residents present in the residential care building.

The final assessment framework for this will not only be used for residential care buildings, but also for all care facilities with similar configurations, namely common areas that are located in an evacuation route. Similarly, not only fire safety in the case of the elderly is considered, but this can also be applied to all types of residents (in particular self-reliant or non-self-reliant, young people, adults and the elderly).

In order to establish an adequate assessment framework, it is necessary to identify the effectiveness of smoke control measures. During this study, various innovative applications of smoke control will be investigated and it will be determined for which evacuation strategies they can or cannot be used.

1.4 RESEARCH METHODOLOGY

In the first phase of the study, five large-scale fire tests will be carried out. During these large-scale tests, the effect of the smoke control systems/techniques will be investigated on a reconstructed situation in laboratory conditions, whereby a pre-defined fire scenario will be tested in practice.

These tests are necessary in order to investigate the effectiveness of active and passive fire safety systems. During the large-scale tests – supplementary to the (first) VIPA study – the effectiveness of a smoke control system (whether or not in combination with an automatic extinguishing system) will be investigated. In addition, the effectiveness of smoke control doors – in case of high overpressure – will be investigated in practice.

In a second phase, CFD simulations (CFD: Computational Fluid Dynamics) will be performed. Since not all possible configurations of the smoke control system can be tested in practice, CFD simulations will be carried out to investigate the influence on the parameters to be investigated (e.g. pressure difference, visibility,...) and to determine under which conditions the smoke control system can be used.

In a third and final phase, the field of application of the smoke control system will be defined. This will be done on the basis of the results obtained during the large-scale fire tests and the CFD simulations. In this phase, it will also be explained which parameters have an influence on the effectiveness of the smoke control system.

1.5 OPERATION AND COMPOSITION OF THE STEERING COMMITTEE

The research is supervised by the contracting authorities (VIPA and EWI), assisted by a steering committee.

The fire program (i.e. the final set-up and the fire scenarios), the scope and validation of the additional CFD simulations as well as the draft final report have been submitted for advice to the steering committee that is convened and assembled by the contracting authorities.

The composition of the steering committee is as follows:

Organisation	Represented by
Vlaams Infrastructuurfonds voor Persoonsgebonden Aangelegenheden (VIPA)	Mrs. Ann Beusen (chairman)
Departement Economie, Wetenschap & Innovatie (EWI)	Mrs. Veerle Lories
Agentschap Zorg en Gezondheid/TCB	Mr. Eddy Mettepenningen
Agentschap Facilitair Bedrijf	Mr. Peter Bockstaele
Zorgnet Vlaanderen/TCB	Mr. Walter Sablon
VLOZO	Mr. Michiel Mentens
FOD Binnenlandse Zaken	Mr. Jan De Saedeleer
Netwerk Brandweer/HVZ Zone Midwest	Mr. Christian Gryspeert
Netwerk Brandweer/HVZ Fluvia/TCB	Mr. Jan Leenknecht
HVZ Zone Kempen/TCB	Mr. Jan Peelaerts
Netwerk Architecten Vlaanderen (NAV)	Mr. Nico Luyten
Agoria	Mr. Bart Vanbever
ANPI	Mr. Michel Delruelle
UGent/TCB	Mr. Bart Merci
UGent/TCB	Mr. Paul Vandevelde
WTCB	Mrs. Romy Van Gaever
Kingspan Light & Air	Mr. Robby de Roeck
Keller	Mr. Filip Van Meerhaeghe
Rf-Technologies	Mr. Frank Verlinden
Etex Building Performance	Mr. Kurt De Proft
Etex Building Performance	Mr. Karim Van Maele
European Fire Sprinkler Network (EFSN)	Mr. Alan Brinson
Belgian Fire Sprinkler Network (BFSN)	Mr. François Asselman
Federatie Veilig Nederland sectie Verenigde Sprinklerindustrie (VSI)	Mr. John Van Lierop
Johnson Controls	Mr. Arjan ten Broeke
Aquasecurity	Mr. John De Gieter
WFRGENT nv	Mr. Bart Sette
WFRGENT nv	Mr. Pieter Poppe (project manager)

1.6 OPERATION AND COMPOSITION OF THE PROJECT GROUP

The task of the project group is to design systems/techniques to enable smoke control in residential care buildings. There will be taken into account that for the components and/or the configuration of the fire safety systems used, reference can be made to existing Belgian and/or European standards/regulations. In addition, it will be avoided that only one provider is available for the system /technology and of course the specific context of a residential care building will also be taken into account.

The project group is initially composed of a broad representation of companies active in the field of smoke control. Since this are mainly companies that are specialized in the design and /or installation of Smoke and Heat Exhaust Ventilation systems, the SHEVS-industry is mainly represented in this, as shown below:

- Etex Building Performance (producer);
- Keller (designer and installer);
- Kingspan Light & Air (designer and installer);
- Rf-Technologies (producer).

A broad representation of companies active in the field of sprinkler systems was also called upon in the context of the large-scale fire test in which a smoke control system in combination with a sprinkler system was tested. The companies concerned are listed below:

- the Belgian Fire Sprinkler Network (BFSN);
- the European Fire Sprinkler Network (EFSN);
- the Federatie Veilig Nederland section Verenigde Sprinklerindustrie (VSI).

The above-mentioned companies form the project group of this study.

1.7 ACKNOWLEDGEMENTS

WFRGent nv wishes to thank the following parties for their essential contribution to this large-scale project explicitly:

- all members of the project group, for their financial and material contribution to this study:
 - Etex Building Performance;
 - Keller;
 - Kingspan Light & Air;
 - Rf-Technologies;
 - the Belgian Fire Sprinkler Network (BFSN);
 - the European Fire Sprinkler Network (EFSN);
 - the Federatie Veilig Nederland section Verenigde Sprinklerindustrie (VSI).
- Theuma nv, for the delivery of all doors that were part of the study;
- Etex Building Performance, for the delivery of the boards necessary for the construction of the test set-up;
- the employees of WFRGent, for the preparation and the conduct of the large-scale fire tests.

2 SMOKE CONTROL

2.1 PREDETERMINED LEVEL OF SAFETY

With prescriptive legislation, such as in Flanders, it is not (always) possible to find out on which criteria the performance requirements are based (so that the functional requirements are met), while with a performance based legislation it is not always clear how an equivalent degree of protection can be demonstrated. In the latter case, however, criteria have been drawn up that can be "checked" in order to demonstrate an equivalent degree of protection (= level of safety) and thus guarantee a safe evacuation.

In the Dutch IFV study (Smoke propagation in indoor buildings – fire in room) [4] such criteria were used to check whether the safety level was achieved. In a table, different limit values were laid down in [4] in function of the type of user, in particular: general, vulnerable and very vulnerable.

The determination of the predetermined safety level was also addressed in the study [3], whereby the steering committee in this study is of the opinion that such a table will not be used for the following reasons:

- It is very difficult to validate the limit values described above on (types of) persons.
- It is very difficult to predict the composition of the smoke (in CFD simulations).

In contrast to [2], the steering committee of the study [3] believes that avoiding any exposure to smoke is a too strict criterion. Exposure to smoke should be avoided as much as possible, i.e. a 'limited exposure' to smoke can be allowed, as described below.

A user can be exposed to smoke in the following ways, partly depending on the present installations and on the evacuation strategy:

- Smoke layer that builds up from the ceiling, either in the evacuation route (immediate evacuation) or in the room (Defend in Place).
- Smoke closer to the floor (e.g. smouldering fire, or after activation of a sprinkler system and/or smoke control system), either in the evacuation route (immediate evacuation) or in the room (Defend in Place).

In addition, the possible presence of irritating and/or suffocating gases in the room must also be taken into account. After all, these do not only apply to the user himself/herself, but also to the assisting staff and the fire brigade. Moreover, such gases are not always visible.

Conclusion:

Based on the above, the steering committee of the study [3] decided to define "limited exposure" as follows:

- The limited exposure only applies to visible smoke.
- Physical contact of the head with the smoke is not allowed. A smoke-free height of at least 2.1 m is therefore determined.

A 'smoke-free evacuation route' is defined as an evacuation route with no more than the described 'limited exposure' during the evacuation.

2.2 DEFINITION OF 'SMOKE CONTROL'

During an evacuation, care must always be taken to ensure that persons who are evacuating are not exposed to the consequences of a fire, in particular exposure to smoke and other toxic components of the fire source.

This evacuation can be done in two ways:

- *immediate evacuation*: the evacuation starts immediately as soon as the fire alarm is given;
- *delayed evacuation or Defend in Place*: as soon as the fire alarm is given, the resident remains in the room, where he/she is not exposed to the consequences of the fire. The resident is waiting for the staff and/or the fire brigade to carry out the evacuation at a later time, i.e. the evacuation only starts as soon as the circumstances during the evacuation are no longer critical for the resident.

For information: In the Netherlands 'Defend in Place' is better known as the 'Stay in Place' principle.

In the context of this study and the predetermined safety level, smoke control can thus be defined as *guaranteeing a smoke-free evacuation by means of active and/or passive fire safety measures*.

Depending on the chosen evacuation strategy, i.e. an immediate evacuation or a Defend in Place, various fire safety measures will be applied.

In this VIPA study, smoke control will be investigated in the context of the following three applications:

- Creation of a smoke-free evacuation route in the fire room
This application of smoke control can be used in the event of an immediate evacuation if the resident's room gives out on the fire room.
If the fire room is connected to other compartments, this application can also be used in the case of a Defend in Place.
This application is discussed in detail in § 2.3.
- Preventing the spread of smoke (and the spread of other toxic gases) to adjacent compartments
This application of smoke control can be used in case of a Defend in Place.
This application is discussed in detail in § 2.4.
- Making the fire room (= evacuation route) smoke-free
This application of smoke control can be used in case of a Defend in Place.
This application is discussed in detail in § 2.5.

2.3 CREATION OF A SMOKE-FREE EVACUATION ROUTE IN THE FIRE ROOM

2.3.1 Principle

The large-scale fire tests in the first VIPA study have shown that - in case of fire - the common area (= the fire room) is filled very quickly with a huge amount of smoke. For this reason, taking into account the predetermined safety level, no immediate evacuation can be obtained if the resident's room gives out directly on this common area.

In order to obtain a smoke-free evacuation route in the common area (= the fire room), a fire screen (which is installed in the ceiling) will be used. In the event of a fire, this fire screen will go down and can either stop at a predetermined height above the ground (e.g. if obstacles are present in the room) or go down completely.

This way, a (smoke-free) separation is created between the common area (= the fire room) and the room of the resident, making it possible for the latter to evacuate during a fire in the common area.

The smoke control system will ensure that the smoke remains within the boundaries of the fire room (but outside the created evacuation route).

2.3.2 Operation

Depending on the position of the fire screen in relation to the ground, the smoke-free evacuation route will be obtained as follows:

- Fire screen to a height above the ground

Once the fire screen has been placed in its final position, the smoke control system is activated. In this application, inlet openings are located in the created evacuation route and exhaust openings are located in the common area (= fire room). This generates an airflow that keeps the smoke in the fire room. The inlet openings can be applied both in the ceiling and the wall. The exhaust openings can be applied both in the ceiling and at the top of the wall.

This application of the smoke control system is shown schematically in the following figures:

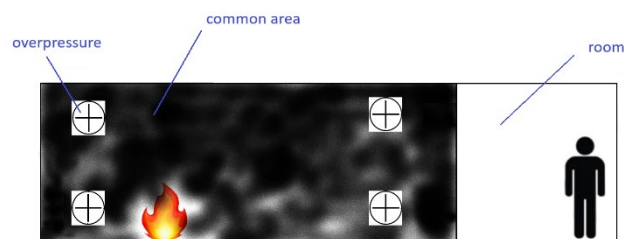

Common area (= fire room) completely filled with smoke: an immediate evacuation from the room is not possible

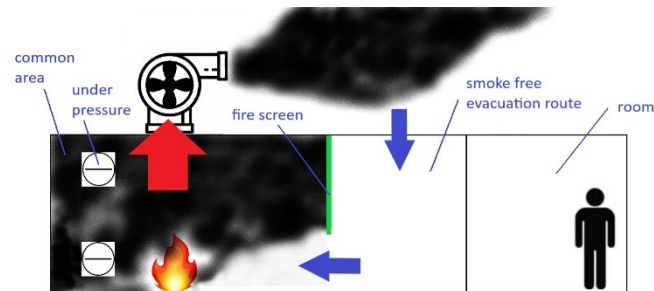

Creating a smoke-free evacuation route by activating the fire screen and smoke control system

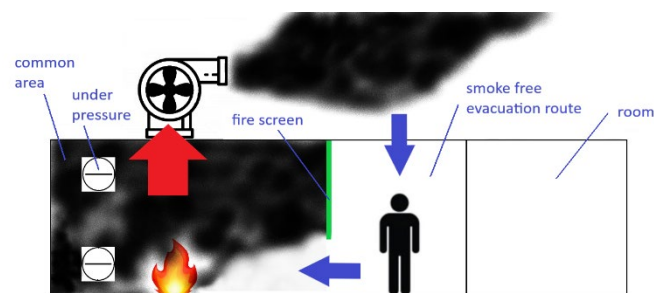

Evacuation from the room through the created smoke-free evacuation route

Figure 1: Schematic representation of the application of a fire screen to a height above the ground

- Fire screen completely down

Once the fire screen has been placed in its final position, the smoke control system is activated. In this application, both the inlet openings and the exhaust openings are located in the common area (= fire room). The inlet openings can be applied both in the ceiling and at the bottom/top of the wall. The exhaust openings can be applied both in the ceiling and at the top of the wall.

This application of the smoke control system is shown schematically in the following figures:

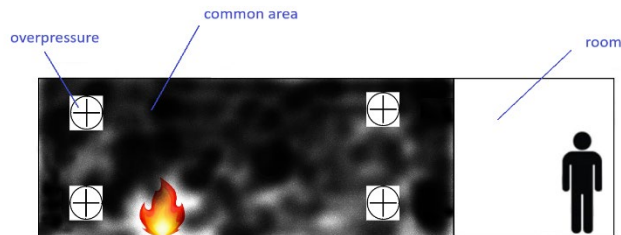

Common area (= fire room) completely filled with smoke: an immediate evacuation from the room is not possible

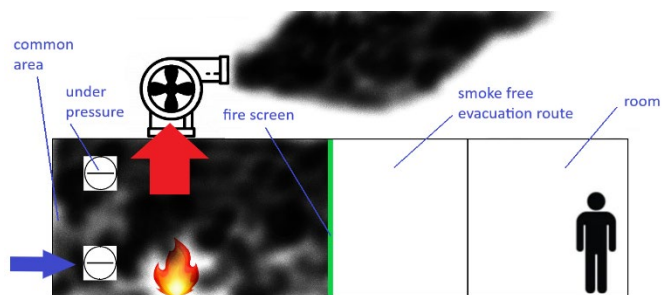

Creating a smoke-free evacuation route by activating the fire screen and smoke control system

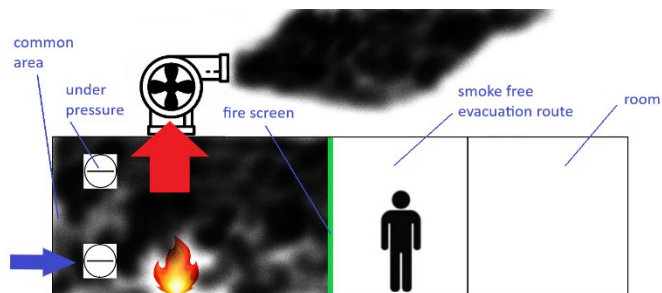

Evacuation from the room through the created smoke-free evacuation route

Figure 2: Schematic representation of the application of a fire screen completely down

2.3.3 Evacuation strategy

By creating a smoke-free evacuation route in the common area (= fire room), this application of the smoke control system can be used in the event of an immediate evacuation if the resident's room gives out on the common area.

If the common area (= fire room) is connected to other compartments (e.g. through the ventilation system, doors, etc.), the smoke control system can provide an underpressure in the fire room (see § 2.4) so that this application can also be used in the event of a Defend in Place.

2.4 PREVENTING THE SPREAD OF SMOKE (AND THE SPREAD OF OTHER TOXIC GASES) TO ADJACENT COMPARTMENTS

2.4.1 Principle

The large-scale fire tests in the first VIPA study have also proven that any overpressure in the fire room will result in smoke propagation to an adjacent compartment. The size of the pressure difference will determine at what velocity the smoke will spread. It has been shown that much higher overpressures are obtained in very airtight buildings compared to less airtight buildings.

Such smoke propagation is of course disastrous to the residents who have to stay in the room if a Defend in Place is applied as an evacuation strategy.

To prevent such smoke propagation, an underpressure must be realized in the fire room. This way, smoke propagation to adjacent compartments is prevented and the resident can wait for the evacuation in a smoke-free environment.

The smoke control system will ensure that the smoke remains within the boundaries of the fire room.

2.4.2 Operation

As a result of a fire, an overpressure (= positive pressure difference) is realized in the fire room compared to an adjacent compartment as shown below. As a result, smoke is "pushed" from the fire room to adjacent compartments at the location of the gaps between the two rooms.

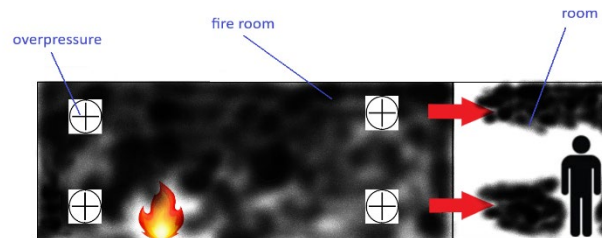

Figure 3: Smoke propagation from the fire room to adjacent compartments under the influence of overpressure (= positive pressure difference)

By applying a smoke control system, an underpressure (= negative pressure difference) is realized in the (fire) room as shown below. This prevents the air in the (fire) room from being moved to the adjacent compartments.

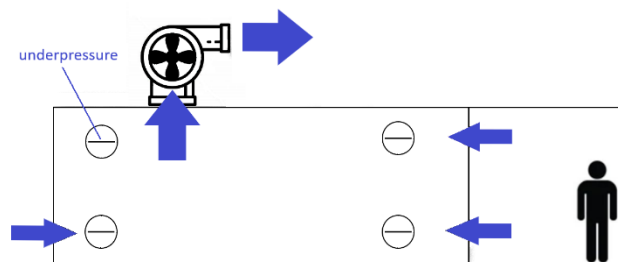

Figure 4: Creating an underpressure in the (fire) room by using a smoke control system

By applying a smoke control system during a fire, the aim is therefore to create an underpressure in the room, so that the smoke remains in the fire room and will not be pushed to adjacent compartments. This is described in more detail in § 5.2.

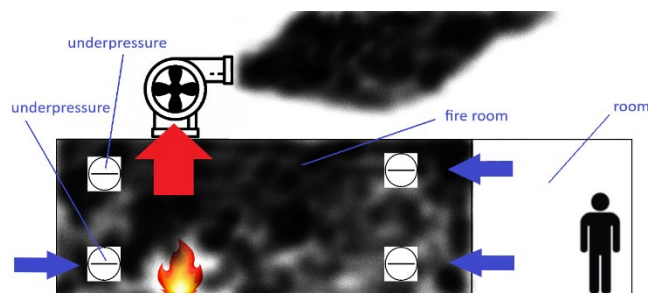

Figure 5: Application of a smoke control system that creates an underpressure in the fire room in the event of a fire

2.4.3 Evacuation strategy

By preventing the spread of smoke from the fire room to adjacent compartments, this application of the smoke control system can be used in the event of a Defend in Place.

2.5 MAKING THE FIRE ROOM (= EVACUATION ROUTE) SMOKE-FREE

2.5.1 Principle

Depending on the phase of a fire, smoke can manifest itself in a room in two ways:

- In the initial phase of a fire, the smoke development and the heat release are rather small, making it possible to obtain a clear separation between a uniform "toxic" smoke layer at the top and the underlying "pure" ambient air.

If a smoke control system is applied in this phase of the fire, the aim will therefore be to obtain a constant minimum smoke-free height in the fire room.

- However, during the further development of the fire, the increasing smoke development – in combination with a low height of the room – will result in the fact that the room will quickly fill with smoke.

In this phase of the fire, the application of a smoke control system will not be able to prevent the pure ambient air from being blended with the smoke layer. Only if there is no more smoke production (i.e. the fire is completely extinguished), a smoke control system can ensure that the present contaminated air (toxic gases and combustion substances) is refreshed by "clean" air within a predetermined time (e.g. after 3 to 5 minutes).

2.5.2 Operation

If the smoke development and the heat release are rather low, a smoke control system can ensure that a minimum smoke-free height is obtained.

If the fire is completely extinguished, it can be obtained that a room can be quickly made smoke-free by imposing a certain refreshing rate.

If the fire is not completely extinguished and therefore a (small) smoke production still takes place, a smoke control system can ensure that, on the one hand the fire room (= evacuation route) is placed in underpressure (see also § 2.4) so that the action of the fire brigade during their intervention – in the case of a (very) airtight fire room – will not cause any further smoke propagation (see further in § 2.5.3) but also, on the other hand, that the visibility in the fire room is improved so that the fire brigade can extinguish the fire completely.

2.5.3 Evacuation strategy

In the case of a Defend in Place, an intervention by the fire brigade is essential in obtaining a successful evacuation. The application of a smoke control system can be an important tool for the fire brigade during their intervention if the evacuation route needs to be made smoke-free.

For information:

During the large-scale fire tests carried out in the IFV study [4], it was ascertained that - in the case of a very airtight room (= fire room) - any action by the fire brigade can cause further smoke propagation. Not only walking through a smoke-filled room, but also opening and closing doors as well as extinguishing actions can all lead to smoke propagation to adjacent compartments to some extent. In particular, the use of an overpressure fan to remove the smoke from the fire room is almost always responsible for the further spread of smoke (and other toxic gases) to adjacent compartments. Such a situation is of course disastrous in the event of a Defend in Place.

2.6 COMPOSITION OF SMOKE CONTROL SYSTEM (= RESIDENTIAL SMOKE CONTROL SYSTEM)

2.6.1 SHEV installation

A SHEV installation (SHEV: Smoke and Heat Exhaust Ventilation) aims to remove the smoke and heat coming from a fire. This installation can consist of SHEV fans and their ductwork, of natural or mechanical smoke ventilation and of (automatic) smoke or fire screens.

The main purpose of a SHEV installation for this application, i.e. in the context of a residential care building, is to ensure the safe evacuation of the residents. This installation can also provide support to the fire brigade during their intervention.

For the design of a SHEV system, the following standards apply (non-exhaustive list):

- NBN S21-208-1 Brandbeveiliging van gebouwen – Ontwerp en berekening van rook- en warmteafvoerinstallaties (RWA) - Deel 1: Grote onverdeelde ruimten met een bouwlaag;
- NBN EN 12101-1 Smoke and heat control systems – Part 1 : Specification for smoke barriers;
- NBN EN 12101-2 Smoke and heat control systems – Part 2 : Specification for natural smoke and heat exhaust ventilators;
- NBN EN 12101-3 Smoke and heat control systems – Part 3 : Specification for powered smoke and heat exhaust ventilators;
- NBN CEN/TR 12101-4 Smoke and heat control systems – Part 4 : Installed SHEVS systems for smoke and heat ventilation;
- CEN/TR 12101-5 Smoke and heat control systems – Part 5 : Guidelines on functional recommendations and calculation methods for smoke and heat exhaust ventilators;
- NBN EN 12101-6 Smoke and heat control systems – Part 6 : Pressure differential systems - kits;
- NBN EN 12101-7 Smoke and heat control systems – Part 7 : Smoke duct sections;
- NBN EN 12101-8 Smoke and heat control systems – Part 8 : Smoke control dampers.

2.6.2 Ventilation system

The purpose of a ventilation system is to replace the air in a room, which for whatever reason is polluted or contaminated, with pure air. Replacing the air can be done naturally or mechanically. In residential care buildings, this is mainly system C (natural/mechanical supply – mechanical exhaust) or system D (mechanical supply – mechanical exhaust).

For the design of a ventilation system, the following standards apply (non-exhaustive list):

- EPB-regulation: Bijlage X Ventilatievoorzieningen in niet-residentiële gebouwen: bepalingsmethode en eisen (Bijlage HVNR);
- NBN EN 16798-1 Energy performance of buildings – Ventilation for buildings – Part 1: Indoor environmental input parameters for design and assessment of energy performance of buildings addressing indoor air quality, thermal environment, lighting and acoustics – Module M1-6;
- CEN/TR 16798-2 Energy performance of buildings – Ventilation for buildings – Part 2: Interpretation of the requirements in EN 16798-1 - Indoor environmental input parameters for design and assessment of energy performance of buildings addressing indoor air quality, thermal environment, lighting and acoustics – Module M1-6;
- NBN EN 16798-5-1 Energy performance of buildings – Ventilation for buildings – Part 5-1: Calculation methods for energy requirements of ventilation and air conditioning systems (Modules M5-6, M5-8, M6-5, M6-8, M7-5, M7-8)– Method 1: Distribution and generation;
- NBN EN 16798-5-2 Energy performance of buildings – Ventilation for buildings – Part 5-2: Calculation methods for energy requirements of ventilation systems ((Modules M5-6, M5-8, M6-5, M6-8, M7-5, M7-8)– Method 2: Distribution and generation.

2.6.3 Composition of the smoke control system (= "residential smoke control system")

SHEV systems consist of components that are resistant to high temperatures and are mainly intended to achieve a clear separation between the pure air and the smoke layer, i.e. a smoke-free height.

Ventilation systems consist of components that are not (always) resistant to high temperatures and are mainly intended to achieve a uniform controlled exchange of contaminated air in a room.

The investigated configurations of a residential care building are mainly characterized by the low height of the possible fire room (= common area - 1 storey). Due to this limited height, the smoke control systems used in this study are outside the scope of the above-mentioned design standards. These smoke control systems are therefore innovative, which means that the applicable design standard sets cannot be used for these.

For the above mentioned reasons and also to make it clear that this application of a smoke control system is different from the known applications of smoke control systems (i.e. atria, industrial buildings and parking garages), the smoke control system used in this study is also called "residential smoke control system".

The smoke control system uses a natural supply and a mechanical exhaust.

During the study, it will be investigated whether an interaction between both systems, i.e. a SHEV system and a ventilation system, is possible.

3 TEST SET-UP OF THE LARGE-SCALE FIRE TESTS

3.1 GENERAL TEST SET-UP

The general test set-up of the large-scale tests is shown schematically in the figure below:

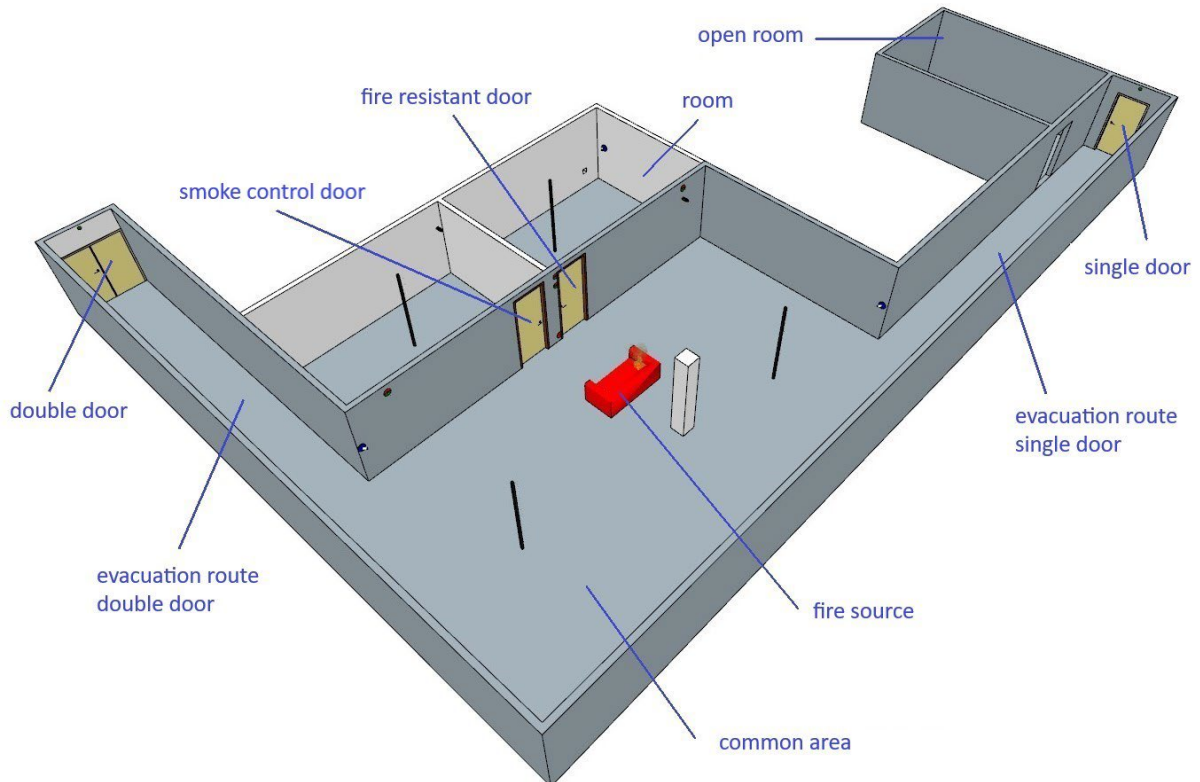

Figure 6: Schematic representation of the test set-up

The general test set-up is composed of the following areas:

- a common area (dimensions: approx. 13.8 m x 7.8 m);
- an evacuation route (dimensions: approx. 1.8 m x 10 m), provided with a double door at the end;
- an evacuation route (dimensions: approx. 1.8 m x 12 m), provided with a single door at the end. An open room (dimensions: approx. 6 m x 4 m) is connected to this evacuation route by means of an opening (width x height: approx. 1 m x 2 m) in the wall;
- two rooms (dimensions: approx. 6 m x 4 m), connected to the common area by means of either a fire resistant door or a smoke control door. Each room has an opening (area: approx. 265 cm²) towards the outside environment. This opening is located at a distance of 0.5 m above the ground.

The test set-up is constructed out of the following materials:

- the walls are made up of aerated concrete (thickness: 150 mm), provided with calcium silicate boards (thickness: 10 mm) on the apparent side;
- the suspended ceiling is composed of a timber framework and calcium silicate boards (thickness: 15 mm) and is installed between the walls, so that a height of approx. 2.5 m is realized;
- the doors at the ends of the evacuation routes are common timber doors. At the end of one evacuation route a single door (width x height: approx. 0.9 m x 2 m) is installed, at the end of the other evacuation route there is a double door (width x height: approx. 2 x 0.9 m x 2 m);
- in the rooms either a fire resistant door or a smoke control door has been installed. The big difference between the two doors (width x height: approx. 0.9 m x 2.3 m) is that the smoke control door has a drop sill at the bottom of the door leaf as well as a rubber seal between the frame and the door leaf;



Figure 7: Smoke control door (drop sill – left; rubber seal – right)

- the fire source is located centrally in relation to the smoke control door and the fire resistant door at a distance of approx. 2 m from the wall with the smoke control door and the fire resistant door.

A few pictures of the test set-up are shown below:



Common area



Common area



Common area



Evacuation route with double door to the end

Figure 8: Pictures of the test set-up

3.2 FIRE SOURCE

A two-seater sofa of the KLIPPAN type (length x width x height: approx. 180 x 88 x 66 cm) has been used as a fire source. The sofa is composed of a timber frame, a polyether foam filling, steel springs and a polyester cover. Six low density fibreboard cubes soaked in heptane are used as an ignition source (ignition source as described in the European test standard CEN/TS 1187-3).

In order to be able to estimate the Heat Release Rate (HRR) of the fire source - just as with the first VIPA study (called VIPA1 in graph below) - the sofa was set on fire under an extractor hood as described in the international standard ISO 9705 (Room Corner Test) prior to the large-scale tests.

The measured Heat Release Rate of the sofa applied in the first VIPA study (VIPA1 in graph below) and the one in the current VIPA study (VIPA2 in graph below) are shown in the graph below:

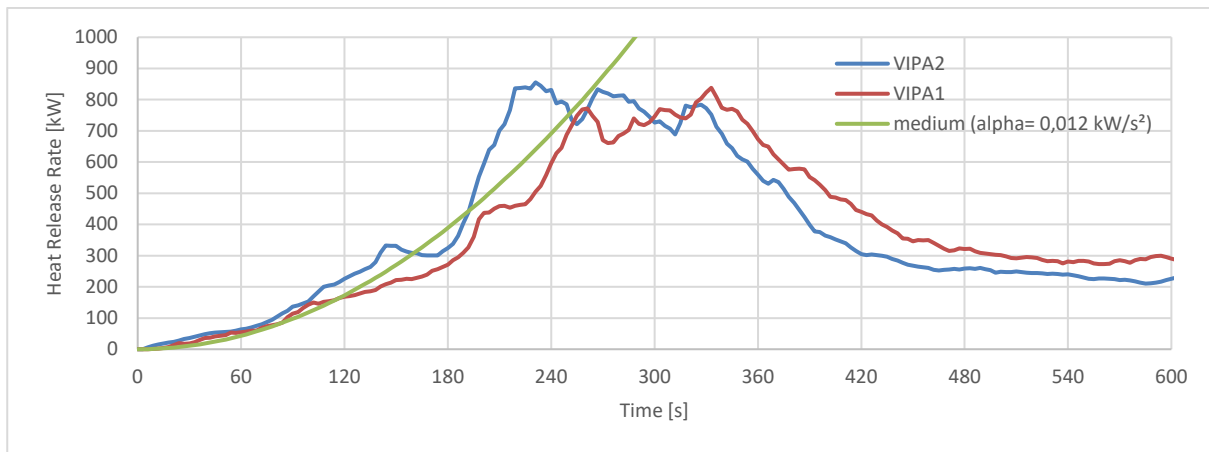

Figure 9: Comparison between the Heat Release Rate of the sofas of VIPA1 and VIPA2

From the figure above can be deduced that the Heat Release Rate of the sofas is close to a medium αt^2 curve, with a maximum Heat Release Rate of approx. 800 kW.

The smoke production of the sofa applied during the current VIPA study is shown below:

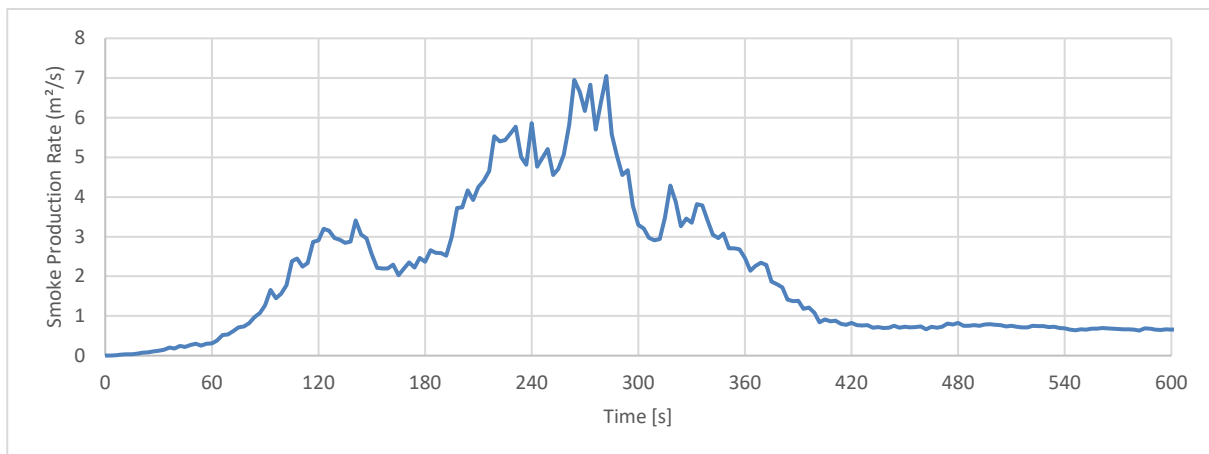
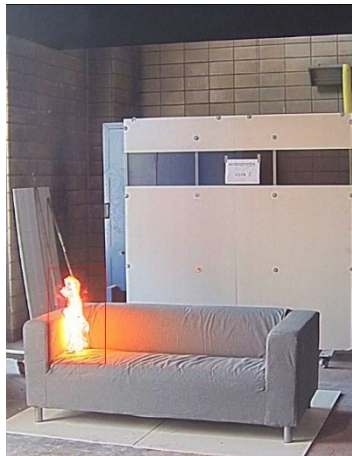

Figure 10: Smoke production of the sofa of the current VIPA study

The fire development of the sofa of the current VIPA study is shown in the figures below:



After 0' 02"



After 1' 00"



After 2' 00"



After 3' 00"



After 4' 00"



After 5' 00"



After 6' 00"

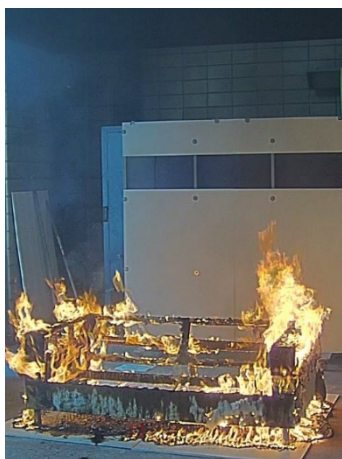

After 7' 00"

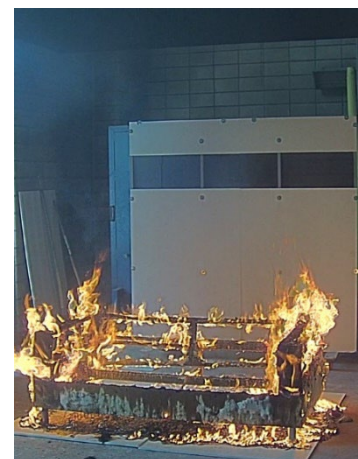

After 8' 00"

Figure 11: Fire development of the sofa of the current VIPA study

3.3 ACTIVE FIRE SAFETY MEASURES

3.3.1 Smoke detectors

Autonomous optical smoke detectors are used during the tests. In practice, the smoke detectors will of course be linked to a fire control panel, but during the large-scale fire tests it is mainly the intention to check the time after which the smoke detector is activated. The position of the smoke detectors is determined as prescribed in the relevant standard. Two smoke detectors are installed in the common area and one in each room.

During the first large-scale fire test (Test 1 "Reference test"), the same smoke detectors are used everywhere, i.e. optical smoke detectors of the type Alecto SA-19/1. From the second large-scale fire test on, a different type of smoke detector is used in the common area, namely optical smoke detectors of the type FHB-150 Midi.

The smoke detectors used are shown in the figure below:



Figure 12: Optical smoke detectors of type FHB-150 Midi (left in each picture) and SA-19/1 (right in each picture)

3.3.2 Smoke control system

The smoke control system used during the large-scale fire tests, is constructed as follows:

- a rectangular air duct (inner dimensions: approx. 1000 x 500 mm; length: approx. 8 m), composed of PROMATECT-L 500 boards (thickness: 30 mm). Just before the connection with the fan, a transition is provided in order to obtain interior dimensions of 1000 x 1000 mm;
- an axial fan of the 1000/6-9/31°/AL/4NALL type (Ø 1000 mm; max. flow rate (at a static pressure loss of 154 Pa): approx. 45,200 m³/h), as shown in the figure below:

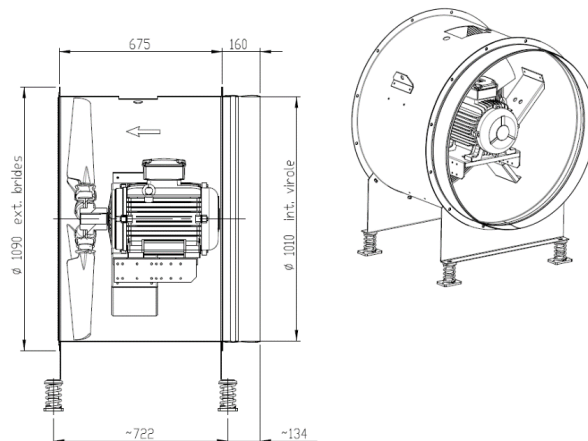

Figure 13: Axial fan used during the large-scale fire tests

Axial fans are mainly used in SHEV systems, because they can extract huge amounts of air. The latter is important because the smoke / temperature must be removed as much as possible. However, an important point of attention of this type of fan is - in the context of pressure control - the sensitivity of the volume flow rate (= extraction flow rate) in relation to the existing pressure difference, namely the higher the pressure difference, the lower the extraction flow rate. This, of course, depends on the choice of fan and the chosen slope of the operating curve;

- a circular galvanized steel duct (Ø 1000 mm; length: approx. 8 m), connected to the other side of the fan.

For the smoke control system, a natural supply and a mechanical exhaust are applied.

Depending on the test, inlet openings and exhaust openings are applied at different locations. An overview of all openings that are applied are shown in the figures below.

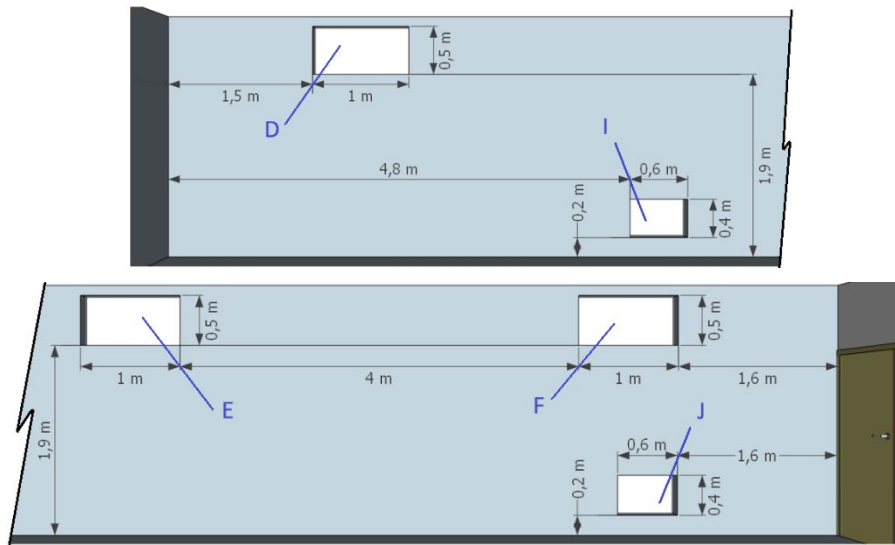

Figure 14: Inlet openings in the wall of the evacuation route with the double door at the end

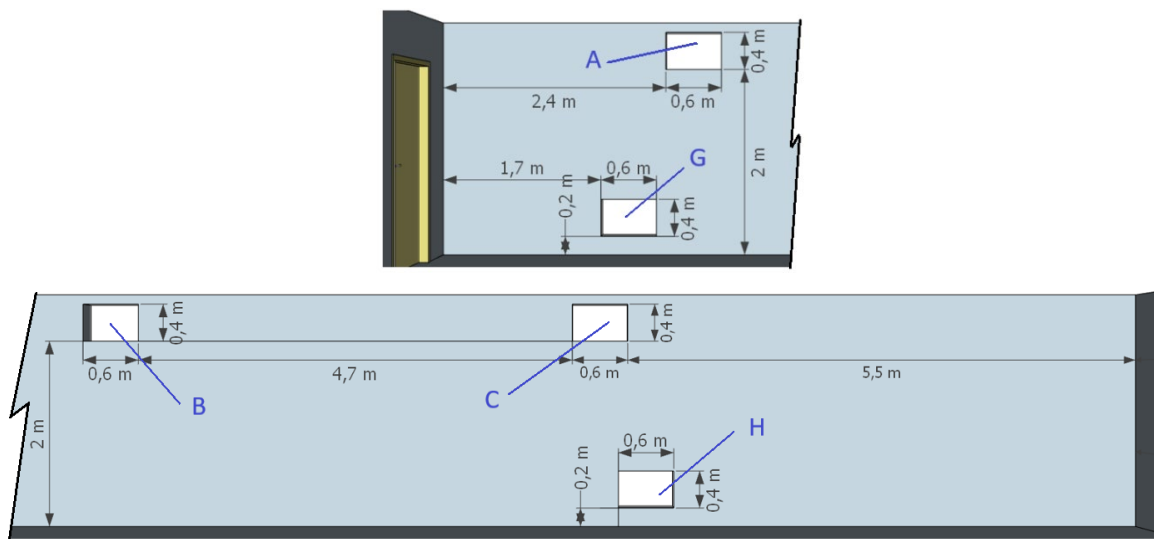

Figure 15: Inlet openings in the wall of the evacuation route with the single door at the end

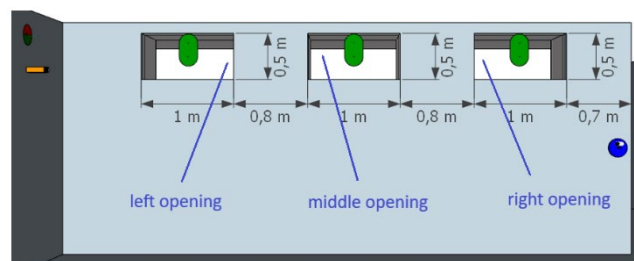

Figure 16: Exhaust openings (the green circles are positions of the temperature measurements) – see also Figure 31

A few pictures of the smoke control system are shown below:



Rectangular duct



Transition rectangular duct to fan



Detail rectangular duct – fan – circular duct



Exhaust openings in the common area

Figure 17: Smoke control system

3.3.3 Fire screen

The fire screen configuration has both an EW90 and an S200 rating (formerly S_m -classification) according to the European standard EN 13501-2.

The fire screen (width: approx. 7000 mm) is applied between steel side guides that are mounted on the wall. The steel casing (height: approx. 200 mm) in which the shaft of the fire screen is located, is attached to the ceiling.

The fire screen configuration is placed according to the manufacturer's installation instructions.

A few pictures of the fire screen configuration are shown below:



Side guide



Casing and side guide



Fire screen up to a height of approx. 0.9 m



Casing

Figure 18: Fire screen configuration

3.3.4 Automatic extinguishing system

The automatic extinguishing system is designed by the project group according to the European standard *NBN EN 16925 Fixed firefighting systems – Automatic residential sprinkler systems – Design, installation and maintenance*.

The steering committee has decided that the fire source should not be positioned centrally in relation to two sprinklers, but rather closer to the sprinkler head that is most air upstream ("colder" air). During the large-scale fire test, the smoke control system will be activated first, which will create an airflow. It is possible that this airflow will not activate the nearest sprinkler head but rather a sprinkler head that is further away and is located more downstream in the "warmer" air, as the heat from the fire source is discharged in that direction. This allows the fire source to be at a greater distance from the activated sprinkler compared to a central positioning between two sprinklers.

Since the position of the fire source must be the same for all large-scale fire tests, the following points have therefore been deviated - at specific request of the steering committee - from the above mentioned design:

- The distance from the sprinkler heads to the wall with the exhaust openings is approx. 2.8 m instead of approx. 1.9 m.
- The coverage of the automatic extinguishing system is limited to the surroundings of the fire source. As a result, only four sprinkler heads are used and not six sprinkler heads.

All other details of the automatic extinguishing system are carried out in accordance with the design of the project group and as described in the relevant standard.

Four residential sprinklers ($K = 70.6 \text{ lpm/bar}^{1/2}$; spray area: $4 \times 4.8 \text{ m}$; operating temperature: 68°C ; distance to ceiling (due to structural limitations): 0.2 m) are therefore installed, as shown in the figure below:

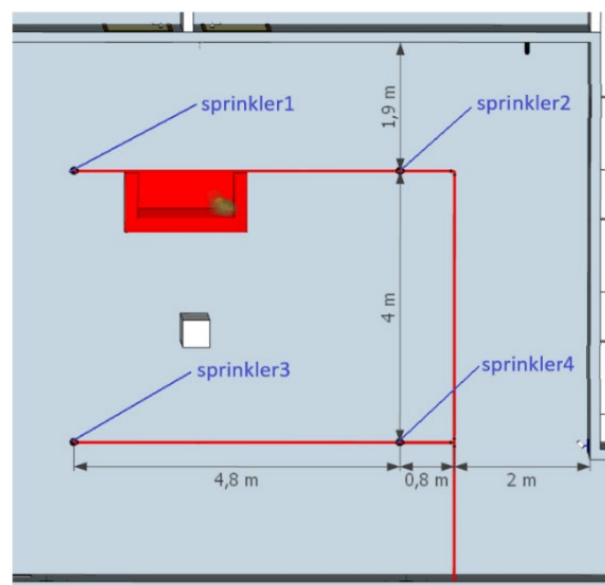
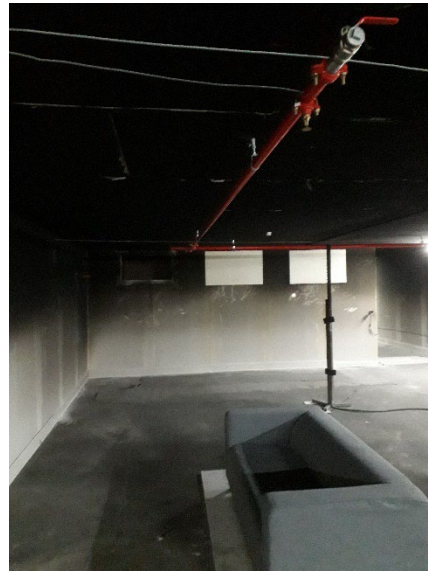

Figure 19: Detail of the automatic extinguishing system (Test 5)

A few pictures of the automatic extinguishing system are shown below:



Detail residential sprinkler head



Location sprinkler head in relation to the fire source



Location sprinkler head in relation to the fire source



Location sprinkler head in relation to the fire source

Figure 20: Automatic extinguishing system

3.4 PASSIVE FIRE SAFETY MEASURES

The height of the tested doors is exceptionally large, i.e. approx. 2.3 m (instead of approx. 2 m as is customary for standard doors). This height has been specifically applied to determine whether the ceiling jet (see also § 5.2.2) coming from the fire source, in combination with an operational height of approx. 2.5 m could have an influence on the spread of smoke to the rooms.

Moreover, both doors are placed directly opposite the fire source so that they are exposed in the same way.

3.4.1 Fire resistant door

The applied fire resistant door is provided with a Benor/Atg approval (fire resistance 30 minutes) and is installed according to its instructions. The compliant placement of this door has been verified by ISIB site inspectors.

For information:

The leak surface of a fire resistant door is not uniform at all edges of the door leaf and is mainly situated at the bottom of the door leaf. After all, there is no rebate at the bottom of the door leaf and therefore the biggest clearance is located there. In addition, the leakage area of the tested door, as calculated in § 3.6 is only valid for the type of door used, i.e. a revolving door. The values of the leak surface will be bigger if it comes to swing doors since with this type of doors the door leaf does not connect against the frame, so that a bigger clearance exists.

3.4.2 Smoke control door

The applied smoke control door is provided with a Benor/Atg approval (fire resistance 30 minutes), also has an S200 classification (formerly S_m -classification) according to the European standard EN 13501-2 and is installed according to its instructions. The compliant placement of this door has been verified by ISIB site inspectors.

For information:

The smoke resistance of a door can be determined according to the European test standard EN 1634-3. In order to obtain an S200 classification (according to the European standard EN 13501-2), the standard volume flow rate of the air through the clearances (including the clearance of the sill) may not exceed 20 m³/h in case of single doors and 30 m³/h in case of double doors. In this case, the tests shall be carried out at a temperature of 20°C and 200°C and an overpressure of 10, 25 and 50 Pa.

The leakage rate of the smoke control door, as calculated in § 3.6 is less than 20 m³/h as described above. In contrast to a fire resistant door, the leakage area of a smoke control door can be considered evenly distributed at the edges of the door leaf.

3.5 MEASUREMENTS

3.5.1 Temperature (measuring equipment from WFRGent nv)

The temperature measurement equipment is identifiable, calibrated and traceable within the quality system monitored by the Belgian accreditation body BELAC in accordance with ISO 17025 of WFRGent nv.

The temperature is measured using thermocouples type K (0 - 1000°C).

Thermocouple trees are placed in four different places (see also figures below). These are used to measure the temperature over the full height at the same place. For this purpose, thermocouples are installed at the following heights: 0.2 m - 0.4 m - 0.6 m - 0.8 m - 1.0 m - 1.2 m - 1.4 m - 1.6 m - 1.8 m - 2.0 m - 2.1 m - 2.2 m - 2.3 m and 2.4 m. So 14 thermocouples are installed per tree.

The positions of these thermocouple trees are shown in the figures below:

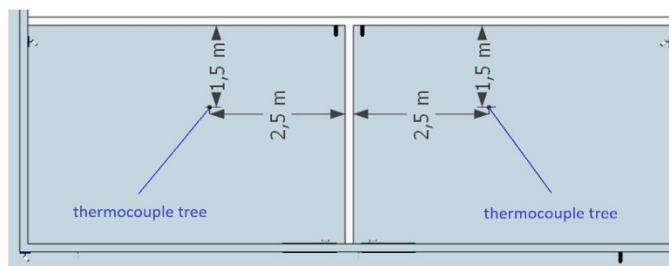
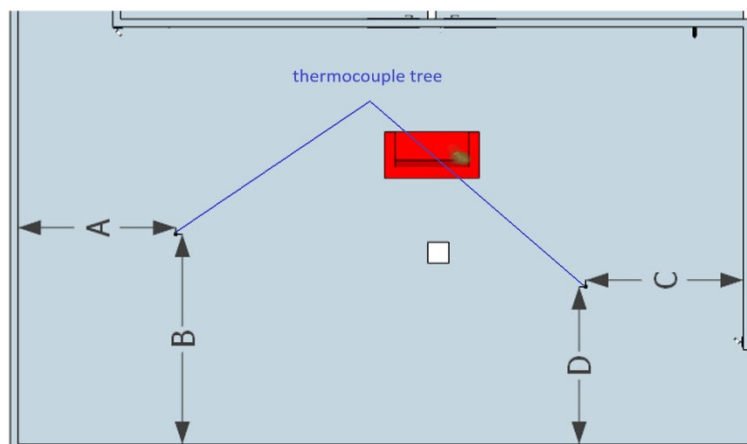

Figure 21: Positions of the thermocouple trees in the rooms



Distance	A	B	C	D
Test 1	3 m	4 m	3 m	3 m
Test 2, 3, 4 and 5	4 m	4 m	4 m	3 m

Figure 22: Positions of the thermocouple trees in the common area

The following thermocouples are also applied:

- in the open room: at a height of approx. 2 m and approx. 2.4 m;
- at the ends of the evacuation routes: above the doors at a height of approx. 2.4 m;
- in the exhaust openings: at a height of approx. 2 m and approx. 2.3 m (see Figure 16 in § 3.3.2);
- in the circular galvanized steel duct, at a distance of approx. 6 m from the fan;
- directly opposite the fire source as shown in the figures below:

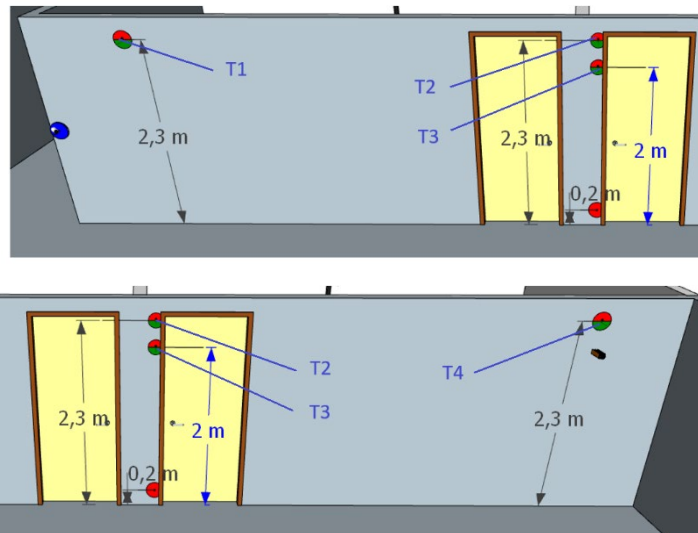

Figure 23: Temperature measurements directly opposite the fire source

- on the wall in the evacuation route with the double door at the end (see also figure below):

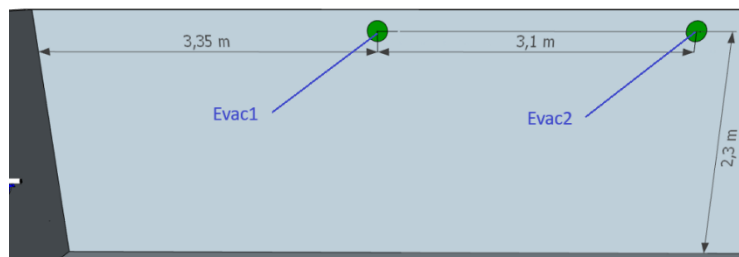

Figure 24: Temperature measurements on the wall in the evacuation route with the double door at the end

3.5.2 CO content

The CO content is measured using a Mobile Device of type Testo 440 with CO probe (measuring range: 0 – 500 ppm; accuracy: ± 5 ppm).

The CO probes are placed at a height of approx. 2 m.

3.5.3 Pressure difference

The pressure difference (compared to the start of the fire test) is measured using a mobile device of the Testo 440 dP type (measuring range: -150 hPa + 150 hPa; accuracy: ± 5 Pa). The results of these measurements are shown as average values over 10 seconds.

During Test 1, the pressure difference between the common area and the outdoor environment is measured. During all other tests, the pressure difference between the common area and the rooms is measured.

The pressure difference is measured at the following positions in the common area:

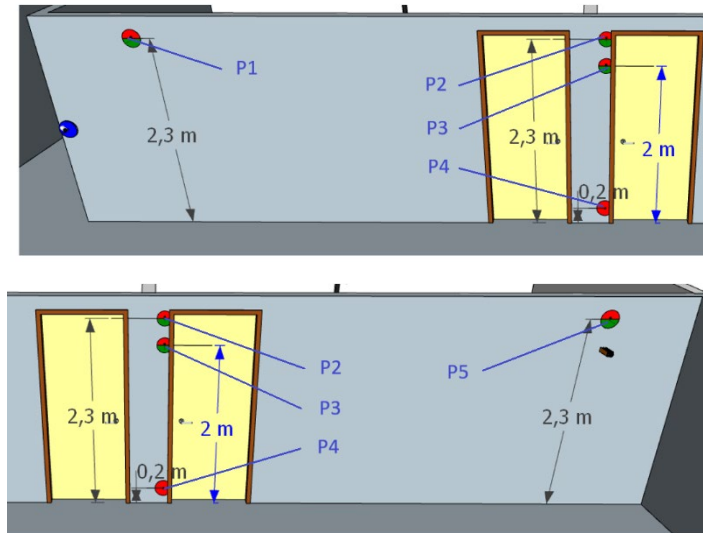

Figure 25: Pressure measurements directly opposite the fire source

During Test 3, Test 4 and Test 5, the position of P1 is moved to the evacuation route that gives out on the double door as shown in the figure below:

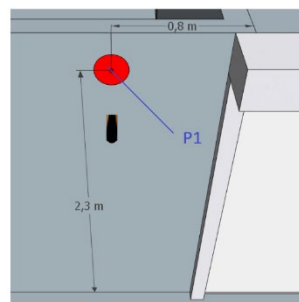

Figure 26: Pressure measurement in the evacuation route with a double door at the end

3.5.4 Cameras

A total of six cameras of the Hikvision DS-2CD2043G0-I 4 MP type are used. These cameras are positioned on the wall at a height between approx. 1 m and approx. 1.2 m.

3.6 AIRTIGHTNESS

Prior to the tests, the airtightness of the building (interior volume: approx. 430 m³) is determined.

The determination of the air permeability is carried out in accordance with the standard NBN EN ISO 9972 *Thermal performance of buildings – Determination of the air permeability of buildings – Fan pressurization method (ISO 9972:2015)*.

Its determination is carried out by means of an air displacement device placed in one of the openings of the building. Subsequently, the existing doors are sealed one by one in order to determine the leakage area of each opening.

For the test set-up, this relates to the following openings (see also figure below):

1. Opening A: single standard door at one entrance.
2. Opening B: fire resistant door at the room.
3. Opening C: smoke control door at the room.
4. Opening D: double standard door at the other entrance.

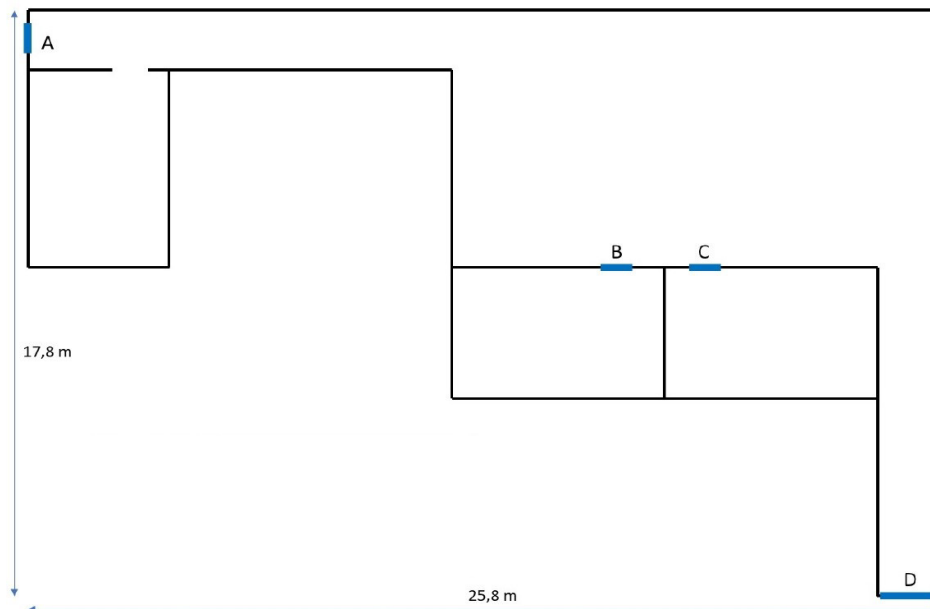

Figure 27: Schematic representation of the airtightness openings

The airtightness measurements are carried out by the WTCB (Wetenschappelijk en Technisch Centrum voor het Bouwbedrijf).

The results of these measurements are shown in the table below.

Sealed openings	Fan position	Average leakage rate at 50 Pa [m ³ /h]	Infiltration rate at 50 Pa [1/h]	Actual leakage area [cm ²]	Ref. test report
None	A	1741	4.05	392.7	HVAC-20-004-01/NL
B	A	1411.4	3.28	321.1	HVAC-20-004-02/NL
B+C	A	1401.8	3.26	318.1	HVAC-20-004-03/NL
B+C+D	A	1208.1	2.81	269.4	HVAC-20-004-04/NL
A+B+C	D	1197	2.78	267.8	HVAC-20-004-05/NL
B+C	D	1452	3.38	336.5	HVAC-20-004-06/NL

Based on the above, the leakage area for the different openings are determined:

Opening	Leakage rate (at 50 Pa) [m ³ /h]	Leakage area [cm ²]
Single door (opening A)	255	69
Fire resistant door (opening B)	330	72
Smoke control door (opening C)	10	3
Double door (opening D)	194	49
Outer shell building (average)	1203	269
TOTAL	1990	461

With an interior volume of approx. 430 m³ and a leakage rate (at 50 Pa) of approx. 1203 m³/h, the outer shell of the test set-up has an infiltration rate of approx. 2.8/h (at 50 Pa) and can therefore be considered a normal airtight room (= normal leakage area).

4 LARGE-SCALE FIRE TESTS

4.1 TEST 1: "REFERENCE TEST"

4.1.1 Test configuration

Test 1 is conducted on 13 October 2020.

The test set-up is shown schematically in the figure below:

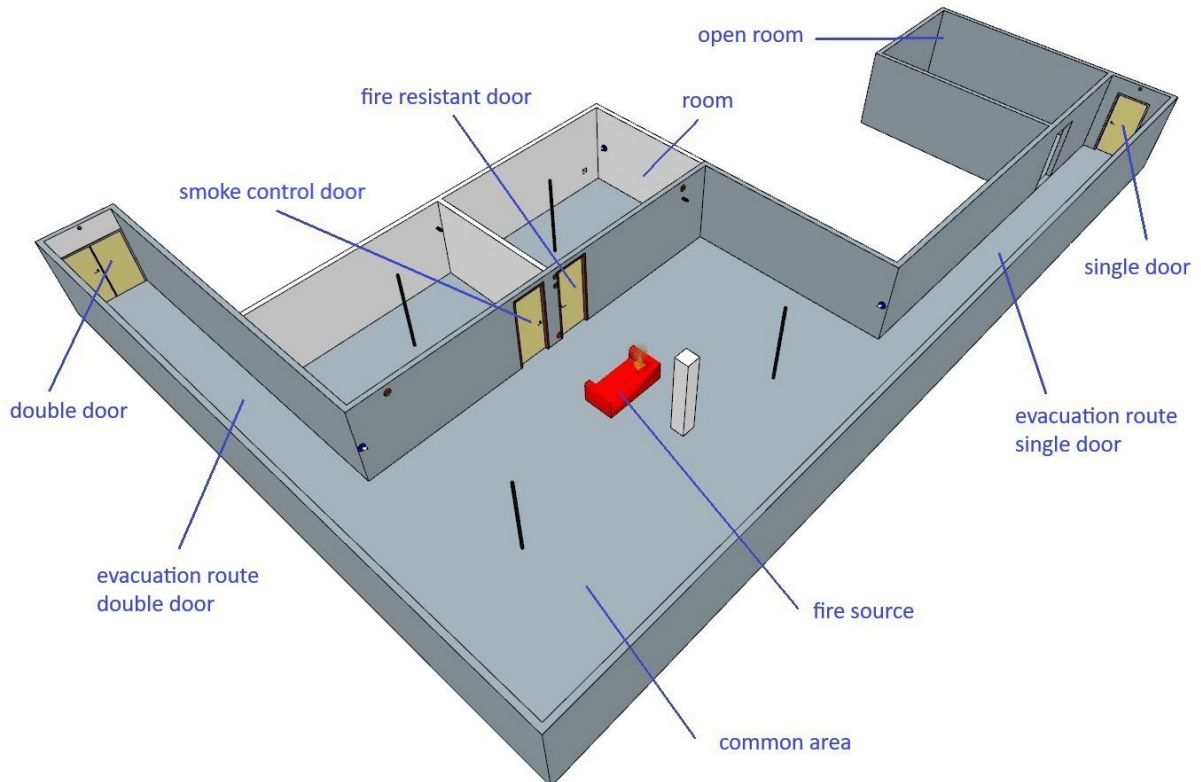

Figure 28: Schematic representation of Test 1

The construction and configuration of this test set-up is identical to the one described in § 3.1.

The locations of the measurements (temperature, pressure and CO) are described in § 3.5.

4.1.2 Purpose of the test

The purpose of this test is to demonstrate the difference in efficiency between a fire resistant door and a smoke control door in the event of a (relatively large) overpressure.

Such (relatively large) overpressure is caused by the fire source and is mainly obtained in airtight rooms. For that reason, there are no openings to the outside environment in the fire room.

4.1.3 Observations during the test

The following observations are made during the test:

Time	Observation
0' 00"	Start of the test.
0' 50"	First smoke detector activated in the common area.
1' 00"	Second smoke detector activated in the common area.
2' 00" to 4' 00"	The smoke layer is visible and lowers quickly.
3' 00"	Smoke detector in the room with the fire resistant door activated.
4' 00"	More and more smoke in the room with the fire resistant door.
4' 30"	Mobile door leaf of the double door at the end of the evacuation route flies open ^(*) .
5' 00"	Mobile door leaf of the double door at the end of the evacuation route is closed again. When closing the door, a pressure wave is created so that a light plume of smoke can be observed through the smoke control door. In the room with the fire resistant door, this is less visually noticeable given the smoke already present in this room.
5' 00" to 7' 00"	The fire extinguishes itself due to lack of oxygen.
7' 15"	Smoke detector in the room with the smoke control door activated.
13' 00"	Mobile door leaf of the double door at the end of the evacuation route is opened in order to evacuate the smoke from the common area.
15' 00"	Single door at the end of the other evacuation route is opened in order to further evacuate the smoke from the common area.
17' 00"	Fixed door leaf of the double door at the end of the evacuation route is opened in order to further evacuate the smoke from the common area.

(*) The double door at the end of the evacuation route is always in direct contact with the (humid) outdoor environment. Since it is a timber door, it is extremely sensitive to moisture. At the start of the test, it was noticed that the door leaf was expanded under the influence of the absorbed moisture, as a result of which the mobile door leaf could no longer be locked. For that reason, the mobile door leaf was clamped against the fixed door leaf, without being locked.

4.1.4 Results of the test

4.1.4.1 Measurements

The results of the measurements carried out (temperature, pressure and CO content) are given in Annex 8.1.

4.1.4.2 Video

The images below are taken in the common area:



After 2'00"



After 3'00"



After 4'00"



After 5'00"



After 6'00"



After 10'00"

The images below are also taken in the common area:



After 2'00"



After 3'00"



After 4'00"



After 5'00"



After 6'00"



After 10'00"

The images below are taken in both rooms. The left column applies to the room with the smoke control door, the right column to the room with the fire resistant door:

Room with smoke control door

Room with fire resistant door



After 2'00"

After 2'00"



After 3'00"

After 3'00"



After 4'00"

After 4'00"



After 5'00"

After 5'00"

The images below are taken in both rooms. The left column applies to the room with the smoke control door, the right column to the room with the fire resistant door:

Room with smoke control door

Room with fire resistant door



After 6'00"

After 6'00"



After 7'00"

After 7'00"



After 8'00"

After 8'00"



After 9'00"

After 9'00"

The images below are taken in the evacuation route with the double door at the end:



After 2'00"



After 3'00"



After 4'00"

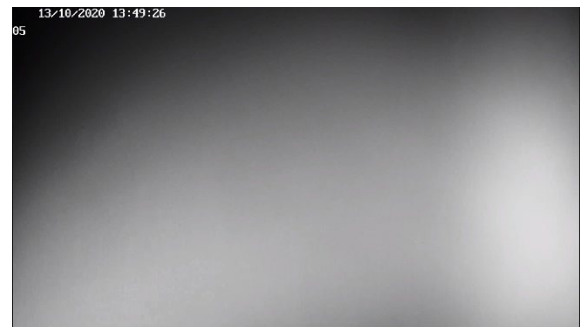

After 5'00"

The images below are taken in the evacuation route with the single door at the end:



After 2'00"



After 3'00"



After 4'00"



After 5'00"

4.1.5 Observations after the test

The following observations are made:

- In the room with the fire resistant door, a large amount of smoke is observed.
- In the room with the smoke control door, a negligible amount of smoke is observed.
- The foam (and cover) of the sofa is completely burned out, except on one side, as shown in the figure below:



Figure 29: Photo of the sofa after Test 1

- The soot release at the rebate of the door is more pronounced at the fire resistant door than at the smoke control door, as shown in the figures below:



Smoke control door
("clean" frame to the left of the rebate)



Fire resistant door
("black" frame to the right of the rebate)

Figure 30: Photos of the doors after Test 1 (difference in soot release)

4.1.6 Analysis of the results of the measurements

The configuration of Test 1, i.e. pressure build-up in a relatively airtight fire room, has already been extensively investigated in the first VIPA study and in other studies. It is known that the size of the overpressure depends on the increase in the Heat Release Rate and/or the dimensions of the openings. The faster the increase in the Heat Release Rate and/or the smaller the openings, the bigger the overpressure. As soon as there is no more increase in Heat Release Rate, the overpressure drops (very quickly).

For this reason, the results of the measurements will not be analysed in this study, as they are not relevant to the purpose of this test, namely to demonstrate the difference in efficiency between a smoke control door and a fire resistant door in the event of a (relatively large) overpressure.

4.1.7 Conclusions of the test

The following conclusions can be made:

- The room fills with smoke very quickly. Although it is a large room (430 m³), the smoke layer has reached the floor approximately 4 to 5 minutes after the start of the fire.
- Even in the case of a normal airtight space (= normal leakage area), a large overpressure (max. 120 Pa) has been established. If this room were even more airtight, the size of this overpressure would be even bigger.
- Since the amount of smoke through an opening - and at a given pressure difference - depends on the dimensions of this opening, it is logical that more smoke has been detected in the room with the fire resistant door. After all, the leakage area of the fire resistant door is much bigger than that of the smoke control door. It should be emphasized that the observed smoke propagation is linked to the types of doors tested and cannot simply be generalized (see also § 3.4).
- Since the amount of oxygen in the fire room is limited, the fire source will not be able to fully manifest itself and we can speak of an under-ventilated fire. The incomplete combustion will (always) result in a more toxic composition of the smoke and in other (toxic and irritating) gases that may be present in the fire room.
- It must be taken into account that the smoke present in a room can be "pushed" to adjacent rooms under the influence of a pressure wave, i.e. a very sudden increase in pressure. This can be, for example, by closing doors, i.e. the spread of smoke as a result of a pressure build-up is not solely caused by the fire source itself (see also § 2.5.1).

4.2 TEST 2: APPLICATION OF A FIRE SCREEN (UP TO 0.9 M ABOVE THE GROUND)

4.2.1 Test configuration

Test 2 is conducted on 30 October 2020.

The test set-up is shown schematically in the figure below:

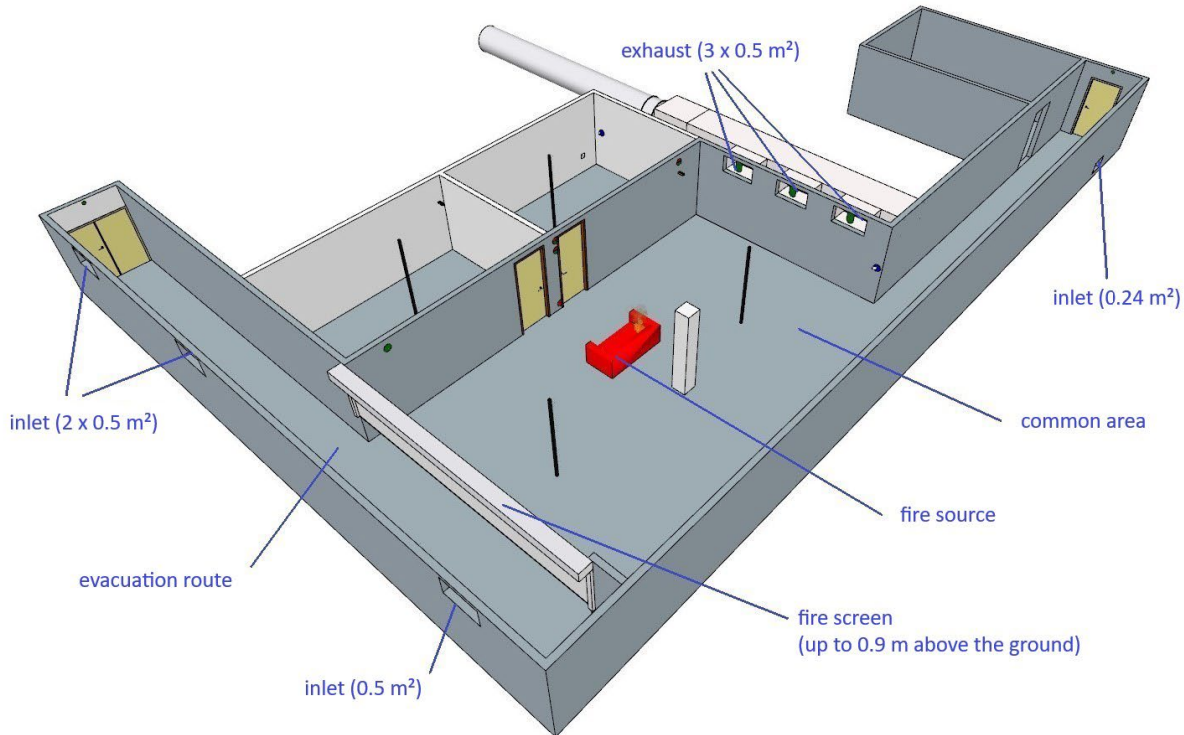

Figure 31: Schematic representation of Test 2

The construction and configuration of this test set-up is identical to the one described in § 3.1 with the addition of a smoke control system (see § 3.3.2) and a fire screen (see § 3.3.3).

The locations of the measurements (temperature, pressure and CO) are described in § 3.5.

The fire screen is located at the ceiling at the start of the test. When activated (= 90 seconds after the start of the test), this fire screen lowers to a height of approx. 0.9 m above the ground.

The smoke control system is switched on manually 110 seconds after the start of the test.

The extraction flow rate is constant and is set to approx. $7 \text{ m}^3/\text{s}$ (= approx. $25,000 \text{ m}^3/\text{h}$).

The openings below are applied in function of the smoke control system (see also § 3.3.2):

- three exhaust openings (width x height (per opening): $1 \text{ m} \times 0.5 \text{ m}$);
- three inlet openings (width x height (per opening): $1 \text{ m} \times 0.5 \text{ m}$) at the top of the wall in the evacuation route with the double door at the end. A fourth inlet opening (width x height: $0.6 \text{ m} \times 0.4 \text{ m}$) is applied at the bottom of the wall in the evacuation route with the single door at the end.

4.2.2 Purpose of the test

The purpose of this test is to create a (new) smoke-free evacuation route in the common area (= fire room). A fire screen is used that lowers at the moment the fire alarm starts and that stops at a height of approx. 0.9 m above the ground. As soon as the fire screen is in the chosen position, the smoke control system is activated. The principle of this test is explained in § 2.3.

The test is successful, i.e. the smoke control system is effective, if no smoke is detected in the created evacuation route.

This application of a smoke control system can therefore be used when an immediate evacuation through the common area (= fire room) is part of the evacuation strategy.

Although both rooms are not part of the safe zone to be created, additional research will be carried out whether smoke propagation to adjacent compartments can be avoided with the help of this application of the smoke control system.

4.2.3 Observations during the test

The following observations are made during the test:

Time	Observation
0' 00"	Start of the test
1' 11"	First smoke detector in the common area activated. The activation of the second detector in the common area is not heard during the test.
1' 30"	Fire screen is activated manually. A small amount of smoke can already be seen in the evacuation route.
1' 50"	Smoke control system is activated manually.
2' 00" to 3' 00"	The smoke layer in the common area is visible. The amount of smoke in the evacuation route has disappeared. The evacuation route is completely smoke-free.
4' 00" to 6' 00"	The thickness of the smoke layer in the common area remains constant and is approx. 1 m.
10' 00"	The smoke layer disappears and visibility in the common area increases.
25' 00"	Almost no smoke perceptible in the common area.

4.2.4 Results of the test

4.2.4.1 Measurements

The results of the measurements carried out (temperature, pressure, and CO content) are given in Annex 8.2.

4.2.4.2 Video

The images below are taken in the common area:



After 2'00"



After 4'00"



After 6'00"



After 8'00"



After 10'00"



After 15'00"



After 20'00"



After 25'00"

The images below are also taken in the common area:



After 2'00"



After 4'00"



After 6'00"



After 8'00"



After 10'00"



After 15'00"

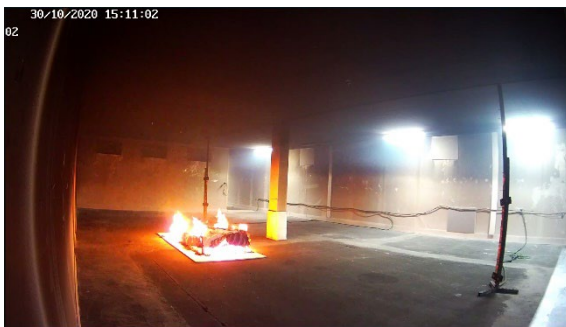

After 20'00"



After 25'00"

The images below are taken in the created evacuation route:



After 1'00"



After 1'30"



After 2'00"



After 3'00"

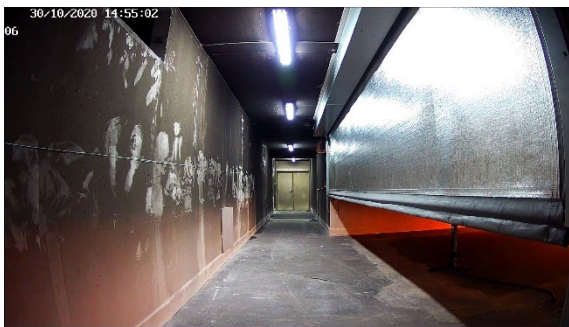

After 4'00"

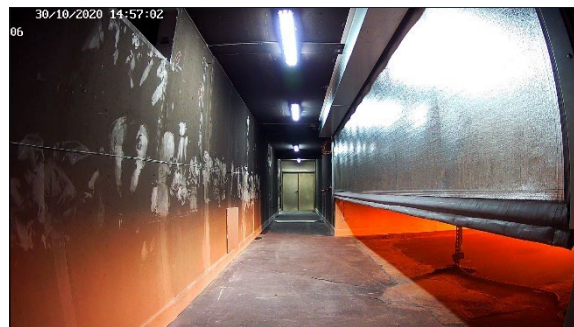

After 6'00"



After 8'00"



After 10'00"

The images below are also taken in the created evacuation route:



After 1'00"



After 1'30"



After 2'00"

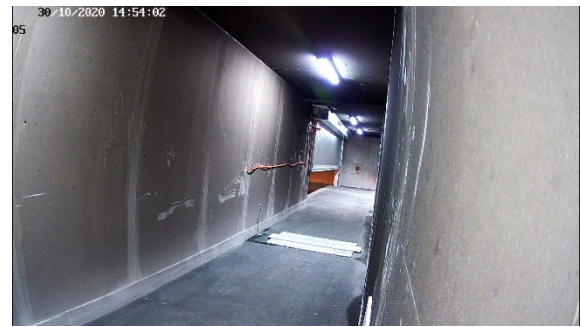

After 3'00"



After 4'00"

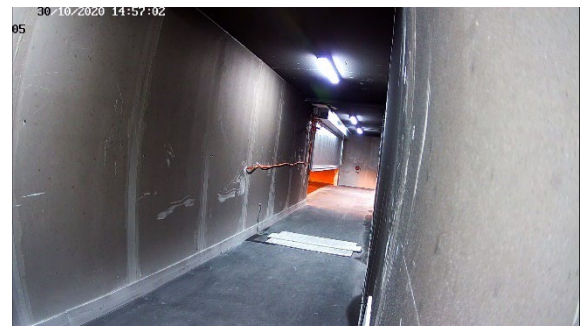

After 6'00"



After 8'00"



After 10'00"

The images below are taken in both rooms. The left column applies to the room with the smoke control door, the right column to the room with the fire resistant door:

Room with smoke control door

Room with fire resistant door



After 2'00"

After 2'00"



After 4'00"

After 4'00"

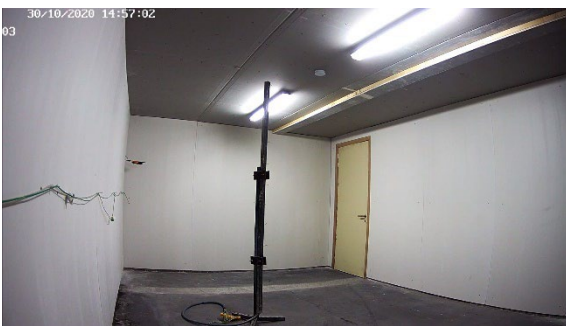

After 6'00"

After 6'00"

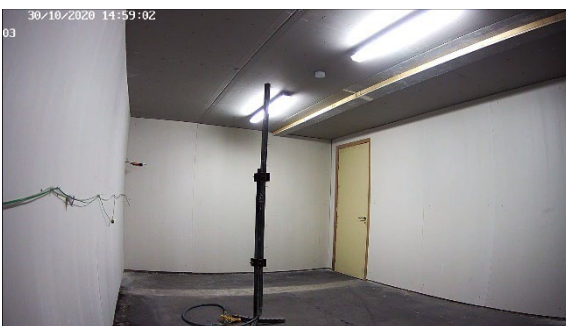

After 8'00"

After 8'00"

4.2.5 Observations after the test

The following observations are made:

- After activation of the smoke control system, no smoke is detected in the created evacuation route.
- No smoke is observed in either room.
- The sofa is completely burned out.

4.2.6 Analysis of the results of the measurements

An analysis of the results of the measurements on pressure and temperature is discussed in more detail on the basis of additional CFD simulations (see § 5.2).

4.2.7 Conclusions of the test

The following conclusions can be made:

- By combining a smoke control system and a fire screen (up to 0.9 m above the ground), a (new) smoke-free evacuation route can be obtained in the common area (= fire room). This allows an immediate evacuation for any resident whose room opens onto this created evacuation route.
- If there is smoke in the evacuation route, the air flow will ensure that this smoke is transported to the extraction openings (in the fire room). As a result, the evacuation route remains smoke-free.
- By creating an additional underpressure in the common area (= fire room), there is no smoke propagation to the adjacent rooms. As a result, this application of the smoke control system can also be used in case of a Defend in Place strategy.
- The smoke control system cannot prevent that surrounding furniture (or other flammable material) in the immediate vicinity of the fire source will contribute to a fire spread (see also conclusion Test 3, mentioned in § 4.6.6 of the study [2]).

The smoke control system is able to keep the temperature in the room low enough so that spontaneous ignition of furniture (or other combustible material) further away from the fire source is avoided.

- This application of the smoke control system has proven to be effective at the fire source used, a specific extraction flow rate and fixed inlet openings. The field of application of this application of the smoke control system, i.e. under which conditions the same effectiveness can be obtained, will be discussed in detail in § 5.3.

4.3 TEST 3: APPLICATION OF A FIRE SCREEN (COMPLETELY DOWN)

4.3.1 Test configuration

Test 3 is conducted on 17 November 2020.

The test set-up is shown schematically in the figure below:

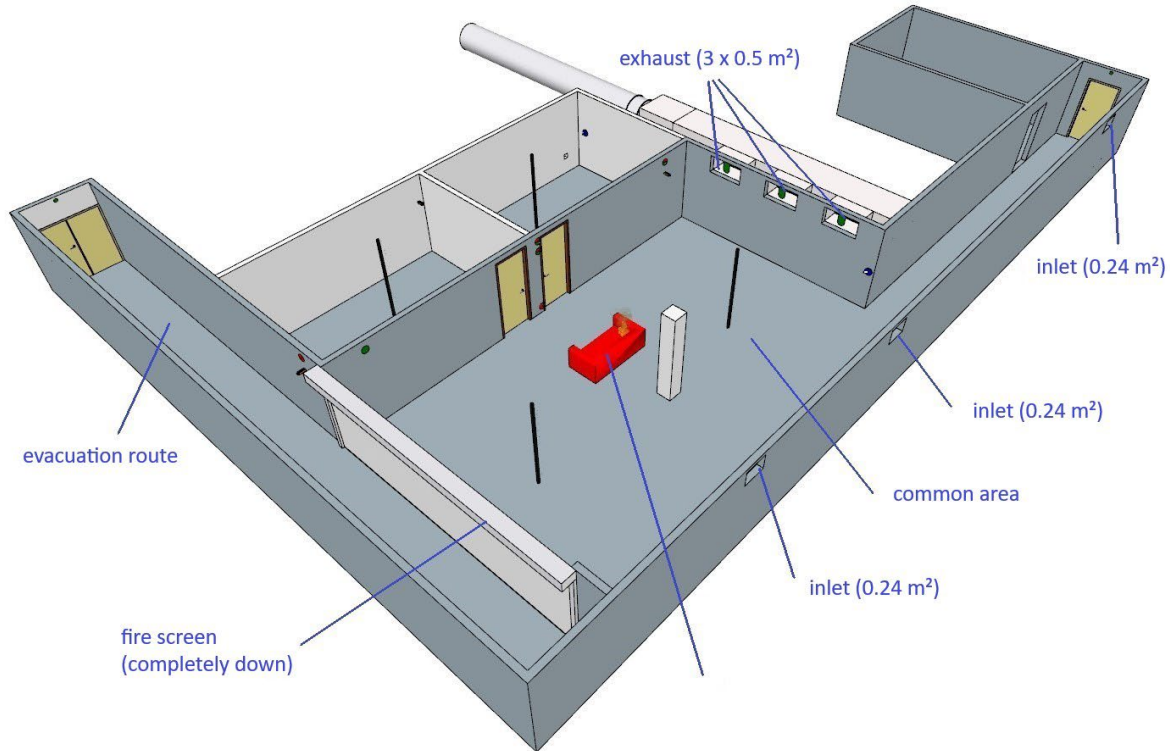

Figure 32: Schematic representation of Test 3

The construction and configuration of this test set-up is identical to the one described in § 3.1 with the addition of a smoke control system (see § 3.3.2) and a fire screen (see § 3.3.3).

The locations of the measurements (temperature, pressure and CO) are described in § 3.5.

The fire screen is located at the ceiling at the start of the test, but unlike the previous test, the fire screen is already activated a few seconds after the start of the test (instead of 90 seconds after the start of the test). After all, it was concluded during the previous test that there was already smoke in the evacuation route before the activation of the fire screen. In the previous test, the smoke present in the created evacuation route was (quickly) discharged to the exhaust openings in the common area.

In this test, however, there is no connection between the created evacuation route and the common area as the fire screen is completely lowered. As a result, it is not possible to check whether the smoke present in the evacuation route solely comes from before the activation of the fire screen. For that reason, the fire screen is already lowered at the start of the test. In actual practice, of course, a connection must always be provided between the evacuation route and the common area in order to remove the smoke that may be present.

The smoke control system is switched on manually 110 seconds after the start of the test.

The extraction flow rate is constant and is set to approx. 5 m³/s (= approx. 18,000 m³/h).

The openings below are applied in function of the smoke control system (see also § 3.3.2):

- three exhaust openings (width x height (per opening): 1 m x 0.5 m);
- three inlet openings (width x height (per opening): 0.6 m x 0.4 m) at the top of the wall in the evacuation route with the single door at the end.

4.3.2 Purpose of the test

The purpose of this test is to create a (new) smoke-free evacuation route in the common area (= fire room). Hereby a fire screen is used that lowers completely at the moment the fire alarm starts. As soon as the fire screen is in the chosen position, the smoke control system is activated. The principle of this test is explained in § 2.3.

The test is successful, i.e. the smoke control system is effective, if no smoke is detected in the created evacuation route after activation of the smoke control system.

This application of a smoke control system can therefore be used when an immediate evacuation through the common area (= fire room) is part of the evacuation strategy.

Although both rooms are not part of the safe zone to be created, additional research will be carried out whether smoke propagation to adjacent compartments can be avoided with the help of this application of the smoke control system.

4.3.3 Observations during the test

The following observations are made during the test:

Time	Observation
0' 00"	Start of the test.
0' 05"	Fire screen is activated manually.
1' 08"	First smoke detector in the common area activated.
1' 24"	Second smoke detector in the common area activated.
1' 50"	Smoke control system is activated manually.
2' 00" to 7' 00"	Visibility in the common area is nil.
10' 00"	Visibility in the common area is almost nil.
20' 00"	Visibility in the common area is improved.
25' 00"	Almost no smoke perceptible in the common area.

4.3.4 Results of the test

4.3.4.1 Measurements

The results of the measurements carried out (temperature, pressure, and CO content) are given in Annex 8.3.

4.3.4.2 Video

The images below are taken in the common area:



After 2'00"



After 4'00"



After 6'00"



After 8'00"



After 10'00"



After 15'00"



After 20'00"



After 25'00"

The images below are also taken in the common area:



After 2'00"



After 4'00"



After 6'00"



After 8'00"



After 10'00"



After 15'00"



After 20'00"



After 25'00"

The images below are taken in the created evacuation route:



After 2'00"

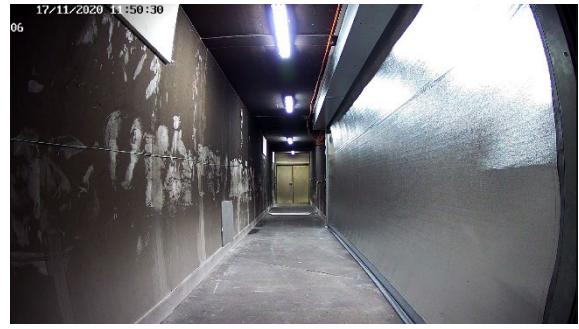

After 4'00"

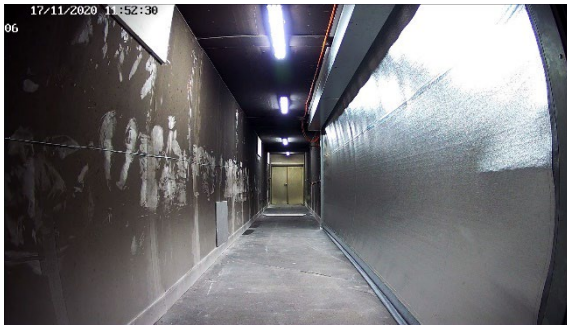

After 6'00"

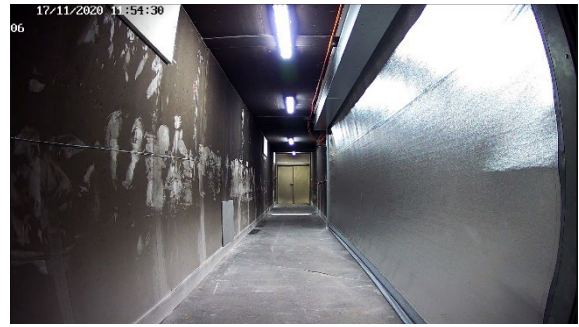

After 8'00"

The images below are also taken in the created evacuation route:

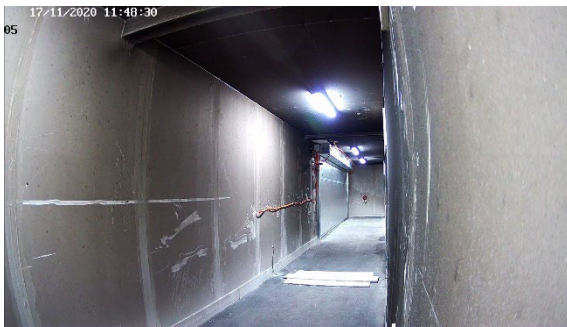

After 2'00"

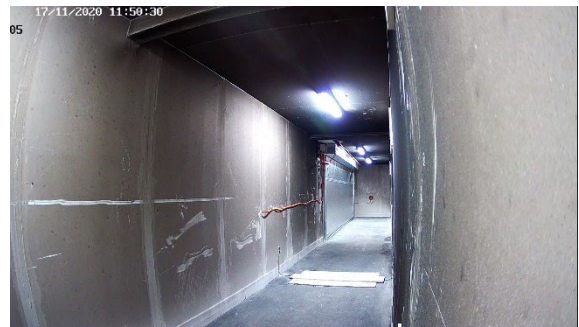

After 4'00"



After 6'00"



After 8'00"

The images below are taken in both rooms. The left column applies to the room with the smoke control door, the right column to the room with the fire resistant door:

Room with smoke control door

Room with fire resistant door



After 2'00"

After 2'00"

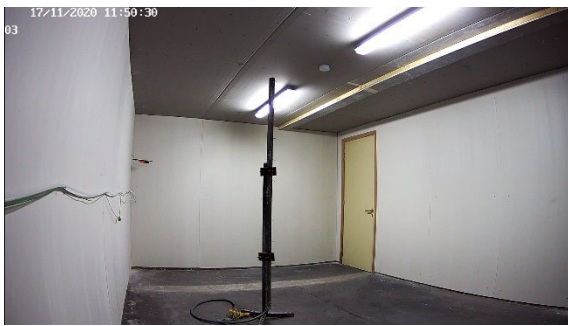

After 4'00"

After 4'00"



After 6'00"

After 6'00"

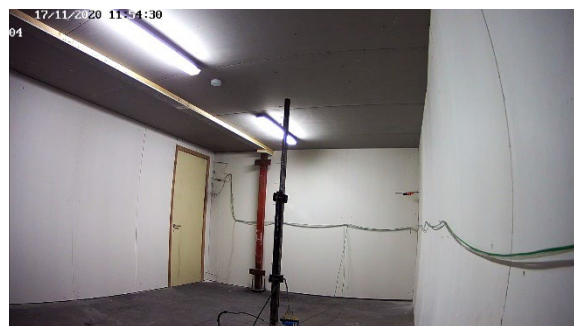
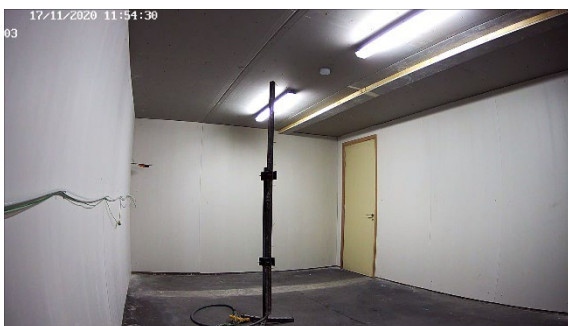

After 8'00"

After 8'00"

4.3.5 Observations after the test

The following observations are made:

- No smoke is observed in the created evacuation route.
- No smoke is observed in either room.
- The sofa is completely burned out.
- The upper half of the fire resistant door and smoke control doors are blackened.

4.3.6 Analysis of the results of the measurements

An analysis of the results of the measurements on pressure and temperature is discussed in more detail on the basis of additional CFD simulations (see § 5.2).

4.3.7 Conclusions of the test

The following conclusions can be made:

- Through the combination of a smoke control system and a fire screen (completely down) a (new) smoke-free evacuation route can be obtained in the common area (= fire room). This allows an immediate evacuation for any resident whose room opens onto this created evacuation route.
- A measure must be taken to prevent a possible smoke propagation to the created evacuation route. This smoke comes from the starting fire and can be present in the created evacuation route before the activation of the fire screen.

Some possible measures are mentioned below:

- provide a buffering (height: min. 25 cm; e.g. a ceiling-mounted fire screen, downstand,...) at the perimeter of the fire room that ensures that the smoke from the starting fire remains in the fire room until the moment the fire screen is activated;
- provide a connection that discharges the smoke in the created evacuation route to the exhaust openings in the fire room.
- By creating an additional underpressure in the common area (= fire room), there is no smoke propagation to the adjacent rooms. As a result, this application of the smoke control system can also be used in case of a Defend in Place strategy.

- The smoke control system cannot prevent that surrounding furniture (or other flammable material) in the immediate vicinity of the fire source will contribute to a fire spread (see also conclusion Test 3, mentioned in § 4.6.6 of the study [2]).

The smoke control system is able to keep the temperature in the room low enough so that spontaneous ignition of furniture (or other combustible material) further away from the fire source is avoided.

- This application of the smoke control system has proven to be effective at the fire source used, a specific extraction flow rate and fixed inlet openings. The field of application of this application of the smoke control system, i.e. under which conditions the same effectiveness can be obtained, will be discussed in detail in § 5.2.

4.4 TEST 4: APPLICATION OF AN ADJUSTABLE SMOKE CONTROL SYSTEM

4.4.1 Test configuration

Test 4 is conducted on 24 November 2020.

The test set-up is shown schematically in the figure below:

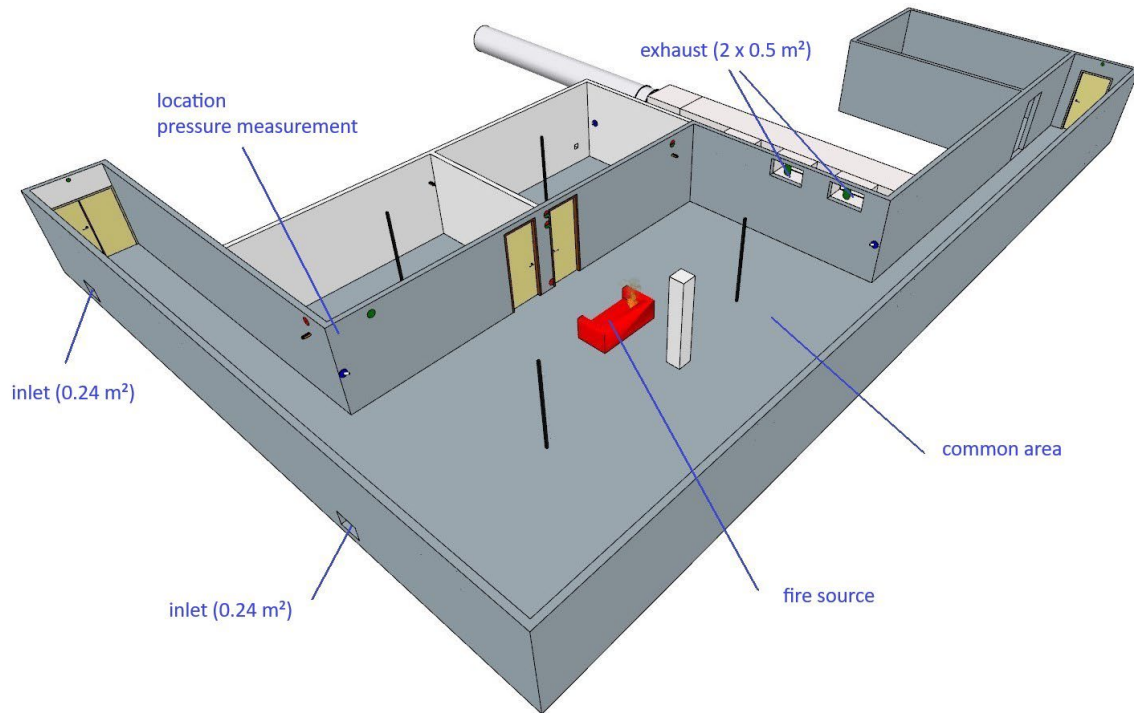

Figure 33: Schematic representation of Test 4

The construction and configuration of this test set-up is identical to the one described in § 3.1 with the addition of a smoke control system (see § 3.3.2).

The locations of the measurements (temperature, pressure and CO) are described in § 3.5.

Contrary to the previous tests, the extraction flow rate is not set constant, but is variable depending on the measured pressure difference in the common area. This pressure difference is measured at a height of approx. 2.4 m and is situated at the location shown in the figure above (at the wall with the smoke control door and fire resistant door). During the test, an underpressure of approx. 25 Pa is set to be maintained.

The smoke control system is switched on manually 90 seconds after the start of the test. From that moment on, the extraction flow rate is determined by the measured pressure difference and is controlled by the pressure control system.

The following openings are made in function of the smoke control system (see also § 3.3.2):

- two exhaust openings (width x height (per opening): 1 m x 0.5 m);
- two inlet openings (width x height (per opening): 0.6 m x 0.4 m) at the bottom of the wall in the evacuation route with the double door at the end.

4.4.2 Purpose of the test

The purpose of this test is to prevent the spread of smoke to adjacent compartments. A pressure control system is used in which the extraction flow rate of the smoke control system adapts itself in function of the measured pressure difference in the room.

The test is successful, i.e. the smoke control system is effective, if no smoke is detected in the rooms and the extraction flow rate is controlled by the pressure control system.

This application of a smoke control system can therefore be used if a Defend in Place strategy is part of the evacuation strategy.

4.4.3 Observations during the test

The following observations are made during the test:

Time	Observation
0' 00"	Start of the test.
1' 10"	First smoke detector in the common area activated.
1' 20"	Second smoke detector in the common area activated.
1' 30"	Smoke control system is activated manually.
2' 00" to 7' 00"	Visibility in the common area is nil.
10' 00"	Visibility in the common area is nil.
20' 00"	Visibility in the common area has slightly improved.
25' 00"	Visibility in the common area has greatly improved.

Remark:

After the fire was virtually extinguished, it was decided to enter the test room while the smoke control system was still active. By opening the (single) door, an additional opening was created, which greatly reduced the size of the realized underpressure. The pressure control system then increased the extraction flow rate, but since the dimensions of the new opening were (very) large, the fan was running at maximum power at that time. It was observed that it was not always easy to close a door that opens towards the room. This will be taken into account upon determining the maximum underpressure to be achieved in the design parameters.

4.4.4 Results of the test

4.4.4.1 Measurements

The results of the measurements carried out (temperature, pressure, and CO content) are given in Annex 8.4.

4.4.4.2 Video

The images below are taken in the common area:



After 2'00"



After 4'00"



After 6'00"



After 8'00"



After 10'00"

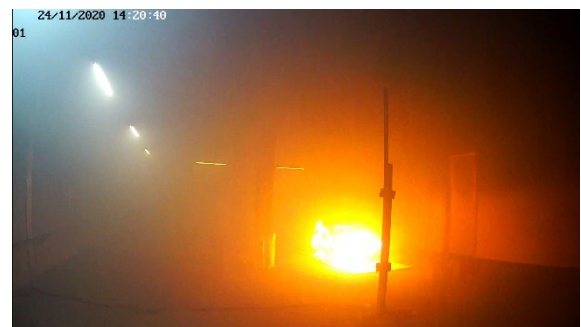

After 15'00"



After 20'00"



After 25'00"

The images below are also taken in the common area:



After 2'00"



After 4'00"



After 6'00"



After 8'00"



After 10'00"



After 15'00"



After 20'00"



After 25'00"

The images below are taken in the evacuation route with the double door at the end:



After 2'00"



After 4'00"



After 6'00"



After 8'00"



After 10'00"



After 15'00"



After 20'00"



After 25'00"

The images below are taken in the evacuation route with the single door at the end:



After 2'00"



After 4'00"



After 6'00"

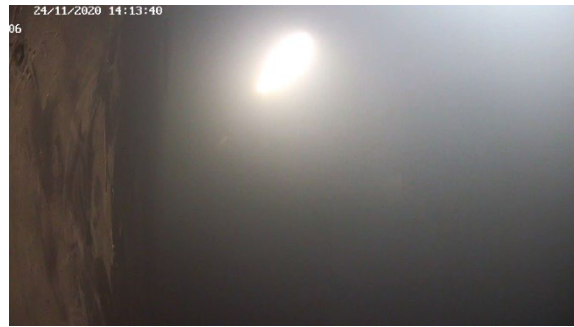

After 8'00"



After 10'00"



After 15'00"



After 20'00"



After 25'00"

The images below are taken in both rooms. The left column applies to the room with the smoke control door, the right column to the room with the fire resistant door:

Room with smoke control door

Room with fire resistant door

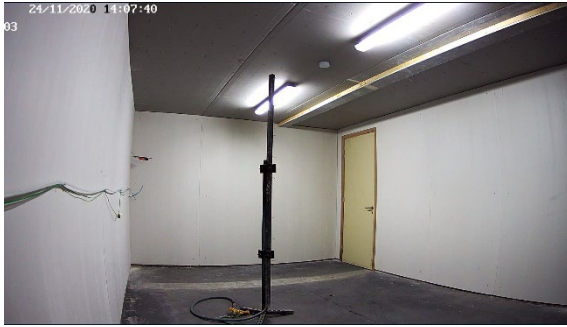

After 2'00"

After 2'00"

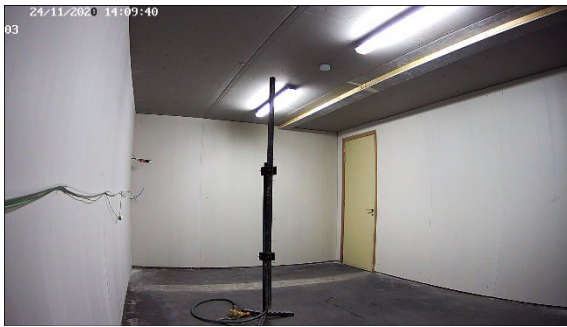

After 4'00"

After 4'00"



After 6'00"

After 6'00"

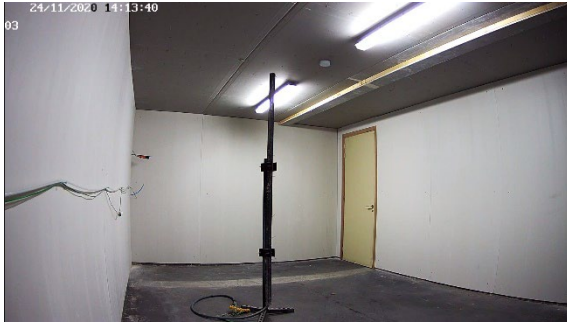

After 8'00"

After 8'00"

4.4.5 Observations after the test

The following observations are made:

- No smoke is observed in either room.
- The sofa is completely burned out.
- The upper half of the fire resistant door and smoke control doors are blackened.

4.4.6 Analysis of the results of the measurements

No analysis of the results of the measurements will be carried out for this test, since during this test it is only intended to demonstrate the functioning of the pressure control system.

For this reason, the velocity of the fan as well as the corresponding measured pressure difference in the common area (= fire room) are also recorded during this test in addition to the measurements mentioned in § 3.5.

The results of these measurements are shown in the graph below:

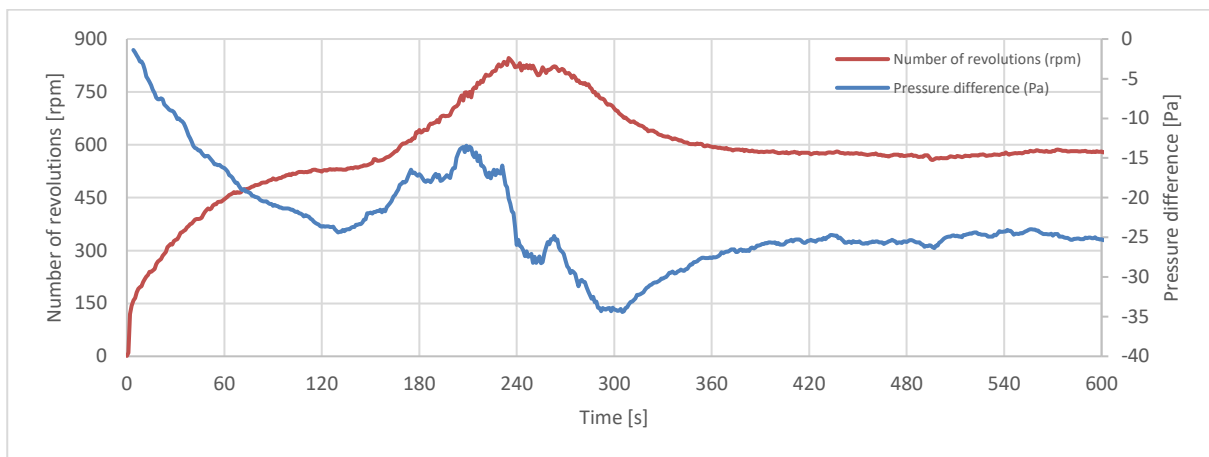

Figure 34: Velocity of the fan in function of the measured pressure difference – Test 4

From the graph above can be deduced that at the beginning of the test logically a higher underpressure is generated at the moment that the velocity (= extraction flow rate) increases. This increase in underpressure is of course necessary to achieve the preset underpressure of approx. 25 Pa.

However, between approx. 120 seconds and 200 seconds after activation (i.e. between approx. 210 seconds and 290 seconds after the start of the test), an increase in the velocity (= extraction flow rate) results in a decrease in the overpressure. This evolution is not as expected, but may have to do with a reduced efficiency of the smoke control system at this stage of the fire.

A possible explanation for this could be the ratio between the inlet openings and the exhaust openings (and therefore also the difference in velocity at the inlet openings and exhaust openings). It is known that in the case of a natural SHEV, the total aerodynamic surface area of the inlet opening must be at least as large as the total aerodynamic surface area of the exhaust openings in order to achieve efficient smoke extraction (see also the Belgian standard NBN S21-208-1). It is therefore also possible that this determination also applies to a system consisting of natural supply and mechanical exhaust.

In order to investigate the influence of the ratio between the inlet opening and the exhaust opening, an additional "cold" test (= test without a fire source) was therefore carried out. During this test, only one exhaust opening was used (width x height: 1 m x 0.5 m) and the velocity is measured at half height of the exhaust point (at three locations) while the surface area of the inlet openings varied. The velocity of the fan of the smoke control system is set constant and has been kept low enough so that no excessive pressure losses are achieved at the inlet opening (see also § 3.3.2).

The results of the velocity measurements in the exhaust opening are shown in the table below:

Total area inlet [m²]	Area exhaust [m²]	Surface area ratio inlet/exhaust [-]	Average measured velocity [m/s]	Measured pressure difference [Pa]
0.25	0.5	0.5	2.8	-12
0.50	0.5	1.0	3.3	-8
0.75	0.5	1.5	3.5	-6
1.00	0.5	2.0	3.9	-3
1.50	0.5	3.0	4.0	-2

From the table above can be deduced that – at a constant set velocity of the fan – the extraction flow rate can vary enormously, depending on the ratio of the inlet openings and exhaust openings. Such a conclusion will be taken into account when formulating the design parameters of the smoke control system (see also § 5.2).

As far as the pressure control system is concerned, it is best to adjust it based on an average pressure difference, measured over 5 seconds.

During the test, measurements were made per second. As a result, large fluctuations are possible, which could cause the pressure control system to react too "abruptly" in order to determine the extraction flow rate.

These fluctuations are shown in the graph below:

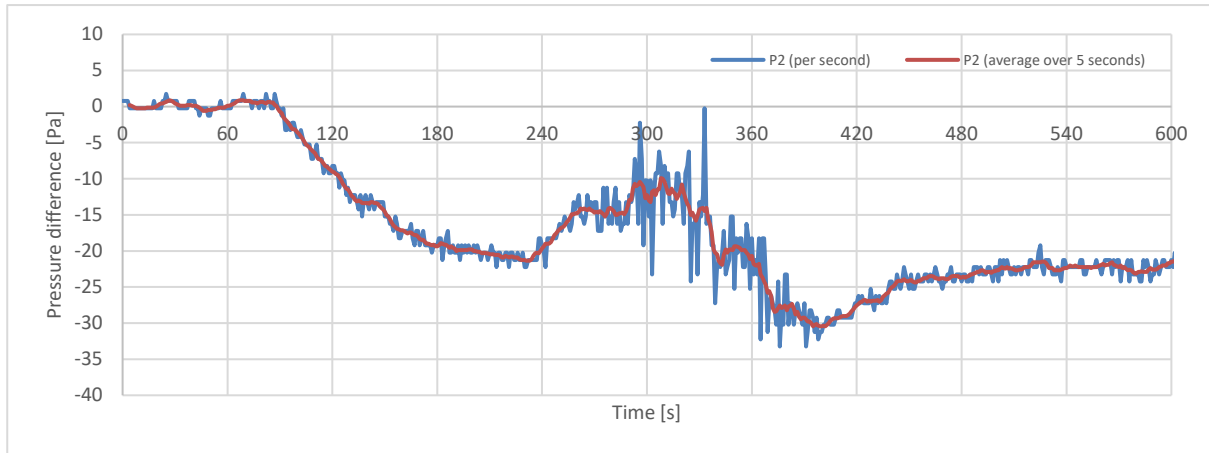

Figure 35: Measured pressure difference (at position P2) during Test 4

4.4.7 Conclusions of the test

The following conclusions can be made:

- By continuously creating an underpressure in the common area (= fire room), no smoke propagation to the adjacent rooms is possible. As a result, this application of the smoke control system can be used in case of a Defend in Place strategy.
- The predetermined underpressure should not be taken too high so that the opening and closing of doors that are connected to the room remain manageable. After all, as long as there is an underpressure in the room (no matter how small), smoke propagation to adjacent compartments is not possible.
- The test has shown that the extraction flow rate of the smoke control system can be controlled in function of the existing pressure difference. However, the ratio of the inlet openings and the exhaust openings must be taken into account in order to guarantee the efficiency of the smoke control system.
- The smoke control system cannot prevent that surrounding furniture (or other flammable material) in the immediate vicinity of the fire source will contribute to a fire spread (see also conclusion Test 3, mentioned in § 4.6.6 of the study [2]).

The smoke control system is able to keep the temperature in the room low enough so that spontaneous ignition of furniture (or other combustible material) further away from the fire source is avoided.

4.5 TEST 5: APPLICATION OF AUTOMATIC EXTINGUISHING

4.5.1 Test configuration

Test 5 is conducted on December 15, 2020.

The test set-up is shown schematically in the figure below:

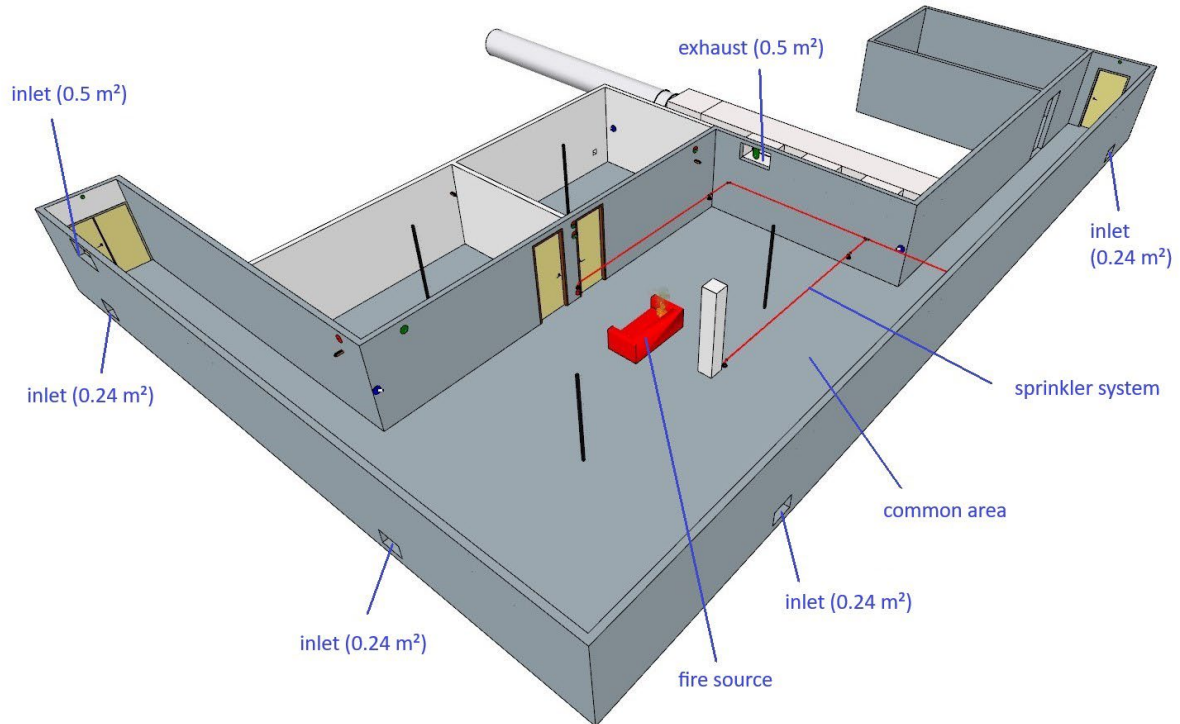

Figure 36: Schematic representation of Test 5

The construction and configuration of this test set-up is identical to the one described in § 3.1 with the addition of a smoke control system (see § 3.3.2) and an automatic extinguishing system (see § 3.3.4).

The locations of the measurements (temperature, pressure and CO) are described in § 3.5.

The smoke control system is switched on manually 90 seconds after the start of the test.

The extraction flow rate is constant and is set to approx. $2.2 \text{ m}^3/\text{s}$ (= approx. $8,000 \text{ m}^3/\text{h}$).

The following openings are made in function of the smoke control system (see also § 3.3.2):

- one exhaust opening (width x height: $1 \text{ m} \times 0.5 \text{ m}$);
- two inlet openings (width x height (per opening): $0.6 \text{ m} \times 0.4 \text{ m}$) at the bottom and one inlet opening (width x height: $1 \text{ m} \times 0.5 \text{ m}$) at the top of the wall in the evacuation route with the double door at the end. Two inlet openings (width x height (per opening): $0.6 \text{ m} \times 0.4 \text{ m}$) are applied at the bottom of the wall in the evacuation route with the single door at the end.

4.5.2 Purpose of the test

The purpose of this test is to verify whether immediate evacuation through a fire room is possible by using a smoke control system and an automatic extinguishing system.

The extraction flow rate of the smoke control system is set low, as it must not adversely affect the proper functioning of the automatic extinguishing system. In addition, sufficient inlet openings were applied. As a result, the velocity at the inlet openings will be low.

Additional research will be carried out whether it is possible to create a smoke layer before the activation of the sprinklers. This can be useful if it concerns a fire that produces smoke rather than heat and an evacuation under the smoke layer is considered.

The test is successful, i.e. the smoke control system is effective, if no smoke is detected in the common area after the activation of both systems and if the fire is controlled by the automatic extinguishing system.

This application of a smoke control system can therefore be used when an immediate evacuation through the common area (= fire room) is part of the evacuation strategy.

Although both rooms are not part of the safe zone to be created, additional research will be carried out whether smoke propagation to adjacent compartments can be avoided with the help of this application of the smoke control system.

4.5.3 Observations during the test

The following observations are made during the test:

Time	Observation
0' 00"	Start of the test.
1' 08"	First smoke detector in the common area activated. The activation of the second smoke detector in the common area is not heard during the test.
1' 30"	Smoke control system is activated manually.
2' 00" to 3' 00"	The smoke layer in the common area is visible.
3' 21"	Activation sprinkler1. Intensity of flames of the fire source increases.
3' 32"	Activation sprinkler2.
3' 38"	Activation sprinkler4.
5' 00"	Fire source under control by the automatic extinguishing system.
6' 00" to 10' 00"	Visibility in fire room has improved.
11' 00"	Resurgence of the fire source.
11' 30" to 20' 00"	Visibility in fire room is almost nil.
25' 00"	Visibility in fire room has improved.

Remark:

As described in the observations, and as seen in the first VIPA study, a resurgence of the fire source has been observed. Here too, the sofa formed a shield, as it were, so that the burning drops of the foam under the sofa could not be completely extinguished, thus causing the fire to flare up again.

It should be emphasized that this resurgence is specific to the applied fire source and test conditions.

4.5.4 Results of the test

4.5.4.1 Measurements

The results of the measurements carried out (temperature, pressure, and CO content) are given in Appendix 8.5.

4.5.4.2 Video

The images below are taken in the common area:



After 2'00"



After 3'00"



After 3'22" (activation 1st sprinkler)



After 3'31" (activation 2nd sprinkler)



After 3'37" (activation 3rd sprinkler)



After 3'45"

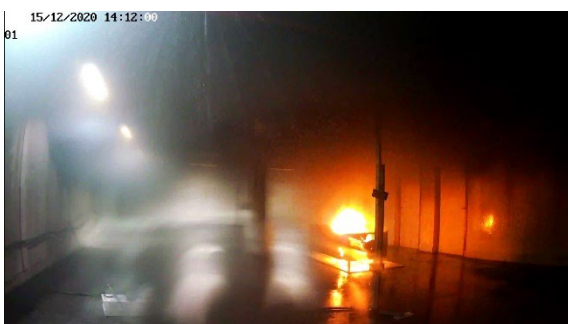

After 4'00"



After 5'00"



After 7'00"



After 10'00"

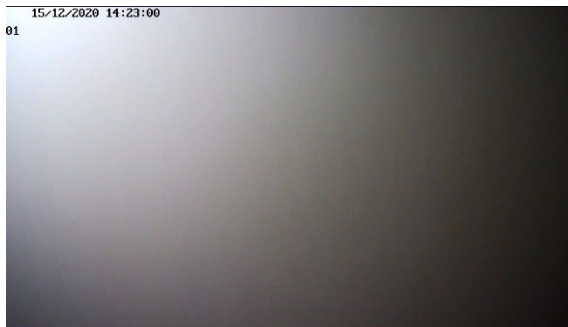

After 15'00"



After 20'00"



After 25'00"



After 30'00"

The images below are also taken in the common area:



After 2'00"



After 3'00"



After 3'22" (activation 1st sprinkler)



After 3'31" (activation 2nd sprinkler)



After 3'37" (activation 3rd sprinkler)



After 3'45"



After 4'00"



After 5'00"



After 10'00"



After 11'00"

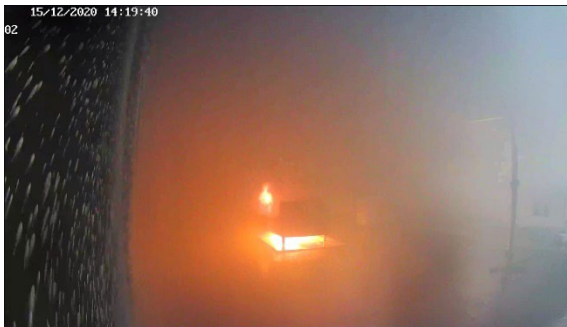

After 11'40"



After 13'00"



After 15'00"



After 20'00"



After 25'00"



After 30'00"

The images below are taken in the evacuation route with the double door at the end:



After 2'00''



After 3'00''

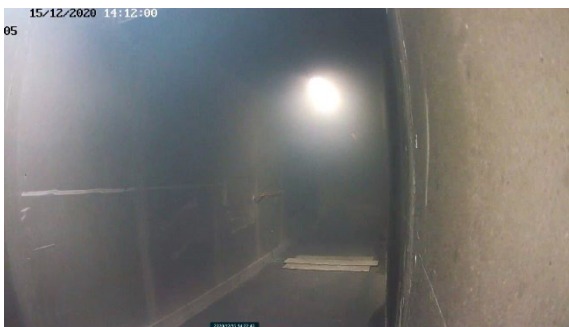

After 4'00''



After 5'00''



After 10'00''



After 15'00''



After 20'00''



After 25'00''

The images below are taken in the evacuation route with the single door at the end:



After 2'00"



After 3'00"



After 4'00"



After 5'00"



After 10'00"



After 15'00"



After 20'00"



After 25'00"

The images below are taken in both rooms. In the left column it concerns the room with the smoke control door, in the right column the room with the fire resistant door:

Room with smoke control door

Room with fire resistant door

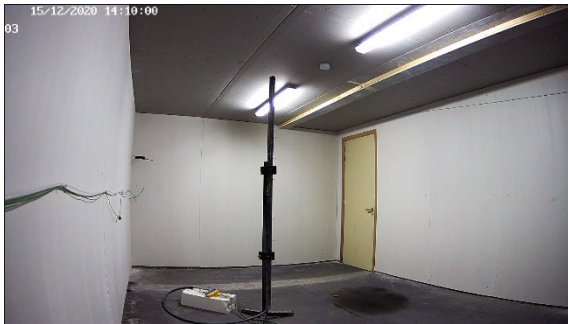

After 2'00"

After 2'00"



After 4'00"

After 4'00"

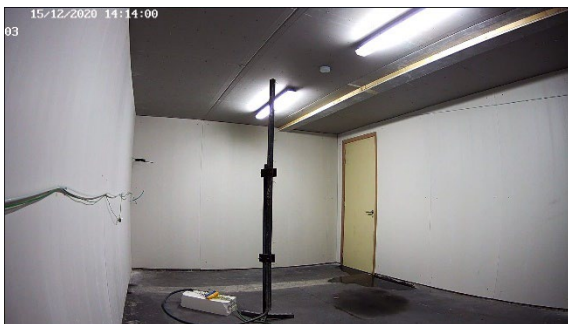

After 6'00"

After 6'00"



After 8'00"

After 8'00"

4.5.5 Observations after the test

The following observations are made:

- No smoke is observed in either room.
- The foam (and cover) of the sofa is completely burned out, except on one side.

4.5.6 Analysis of the results of the measurements

No analysis of the results of the measurements will be carried out for this test, since the purpose of this test is to demonstrate that an automatic extinguishing system can be used in combination with a smoke control system.

The development of a smoke-free height, i.e. a clear separation between a smoke layer and the ambient air, is discussed in § 5.4.

4.5.7 Conclusions of the test

The following conclusions can be made:

- The combination of a smoke control system and a sprinkler system has ensured that there is no smoke propagation to the adjacent rooms. As a result, this application of the smoke control system can be used in case of a Defend in Place strategy.
- However, the combination of a smoke control system and a sprinkler system cannot be used in the event of an immediate evacuation through the fire room (= evacuation route) as no "limited exposure", as defined in § 2.1 (Predetermined safety level), can be obtained.
- The predetermined extraction flow rate of the smoke control system is set too low to discharge the smoke produced during a potential resurgence from the fire source. As a result, visibility is poor and this application of the smoke control system, with the extraction flow rate set too low, cannot be used when an immediate evacuation is part of the evacuation strategy.
If - after the activation of the automatic extinguishing system - a higher extraction flow rate would be set, a better removal of the smoke is possible (so that the visibility will improve rapidly) though hereby it is important to provide sufficient inlet openings. This creates less turbulence in the room and improves visibility (see also § 5.4).
- This application of the smoke control system can be used during an intervention by the fire brigade in a Defend in Place strategy. If the fire is not completely extinguished and therefore a (small) smoke production still takes place, a smoke control system can ensure that, on the one hand, the fire room (= evacuation route) is placed in underpressure so that the action of the fire brigade during their intervention – in the case of a (very) airtight fire room – will not cause further spread of smoke, but, on the other hand, that the visibility is improved so that the fire brigade can completely extinguish the fire.

- The automatic extinguishing system keeps the fire under control, even in the event of a resurgence.

By humidifying the immediate vicinity of the fire source, the automatic extinguishing system prevents that surrounding furniture (or other combustible material) in the immediate vicinity of the fire source will spontaneously ignite.

- By installing larger inlet openings (and thus keeping the velocity at the inlet openings low), a distinct smoke-free height was achieved during the initial phase of the fire.

5 ADDITIONAL CFD SIMULATIONS

5.1 INTRODUCTION

Since for practical and financial reasons not every configuration can be tested, additional CFD (CFD: Computational Fluid Dynamics) simulations are used to investigate the potential impact of changed parameters on the efficiency of the smoke control system.

The purpose of the CFD simulations is a qualitative rather than a quantitative study as the CFD simulations are only an estimate of reality. Results obtained during the CFD simulations can therefore never be assumed as results that will be obtained in reality. During the CFD simulations, however, the influence of a modified parameter on the efficiency of the system can be investigated.

For the CFD simulations, the program FDS (FDS: Fire Dynamics Simulator) was used. This program (version 6.6.0) is a LES model (LES: Large Eddy Simulations), which means that it explicitly calculates the turbulent flows and that the flows that are too small in relation to the cell size (grid size) are approximated. The influence of the cell size (grid size) on the interference of air in the smoke plume is therefore very important. The finer the grid size, i.e. the smaller the cell size, the better the turbulence is displayed.

During the simulations with FDS, the default settings of the program were applied and the cell size (grid size) was set at 10 cm x 10 cm x 10 cm. The thermal properties of the walls and ceiling in the simulations are based on those applied during the large-scale fire tests, in order to also take into account the heat losses through the boundaries of the fire room.

5.2 SMOKE CONTROL SYSTEM TO PREVENT THE SPREAD OF SMOKE

5.2.1 Introduction

Since there are no empirical formulas available for calculating the pressure difference in the fire room under the influence of a fire source and a smoke control system, CFD simulations were carried out prior to the large-scale fire tests in order to have an estimate of the expected pressure difference under the fire conditions specific to each test (i.e. Test 4 and Test 5).

The large-scale fire tests have shown that the smoke control system is effective for the fire source in question, the specific ventilation conditions, the determined extraction flow rate and the dimensions of the fire room.

During these additional CFD simulations, the influence of the following varying parameters (compared to the large-scale fire tests) on the pressure difference in the fire room is investigated:

- the location of the inlet openings and the exhaust openings;
- the location of the fire source;
- the Heat Release Rate and the Heat Release Rate curve;
- the dimensions of the inlet openings;
- the extraction flow rates;
- the dimensions of the fire room.

5.2.2 First some theoretics

In order to better understand the graphs of the additional CFD simulations, it will be explained first how these graphs should be interpreted. So first some theoretics.

Since an airflow always manifests itself from a high to a low pressure area, smoke propagation to adjacent rooms is not possible if an underpressure (= low pressure area) is realized in a fire room.

To determine the size of this underpressure, Bernoulli's equation regarding the flow behaviour of liquids and gases is used:

$$p + \frac{1}{2}\rho v^2 + \rho g z = const.$$

with:

p	pressure [Pa]
ρ	mass density [kg/m ³]
v	velocity [m/s]
g	gravitational acceleration [m/s ²]
z	height [m]

Based on this equation, in the case of a flow through an opening, the following formula can be applied to determine the volume flow rate through this opening:

$$V = C_d A \sqrt{\frac{2\Delta p}{\rho}} \quad (1)$$

with:

- V volume flow rate [m³/s]
- C_d coefficient of contraction [-]
- A surface area of the opening [m²]
- Δp pressure difference [Pa]
- ρ mass density [kg/m³]

From the above equation, the underpressure in a room can be determined on the basis of the aerodynamic surface area (= A x C_d) of the inlet openings and the volume flow rate (of the fan). The above comparison also shows that the smaller the aerodynamic surface area of the inlet openings, the smaller the volume flow rate must be in order to achieve the same pressure difference; as well as that with a constant volume flow rate, the same pressure difference is always obtained.

The principle of creating an underpressure in a room (without a fire) by means of a smoke control system is shown schematically in the figure below:

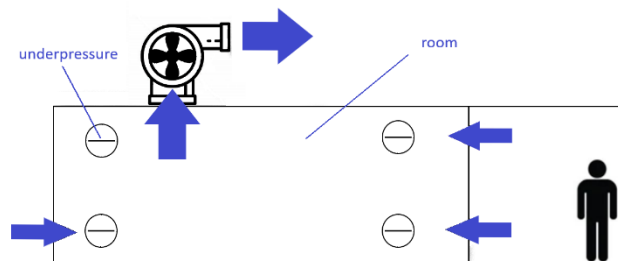

Figure 37: Creating an underpressure in a room by means of a smoke control system

A fire in a room will always create an overpressure in this room. The size of this overpressure (mainly) depends on the dimensions of the openings in the fire room (i.e. the smaller the openings, the higher the overpressure).

The principle in which an overpressure in a room is created by the fire source is shown schematically below:

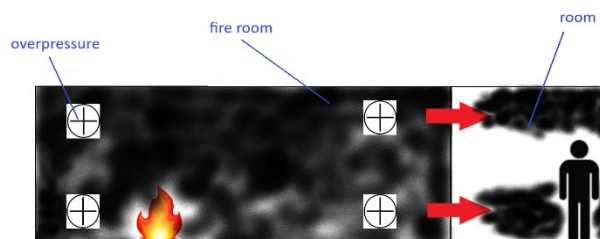

Figure 38: Creating an overpressure in a fire room under the influence of a fire source

At a constant volume flow rate, the originally obtained underpressure will not remain constant, but will be influenced by the fire source. Depending on the size of the volume flow rate and the Heat Release Rate (of the fire source), an underpressure in the entire room (from floor to ceiling) can be obtained in the fire room, as shown schematically below:

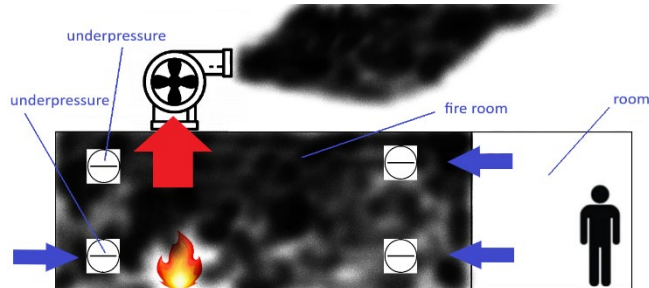

Figure 39: Application of a smoke control system that creates an underpressure throughout the fire room in the event of a fire

However, due to a (too) low extraction flow rate and/or a (too) high Heat Release Rate, it is possible that an underpressure cannot be obtained everywhere in the fire room, as shown schematically below:

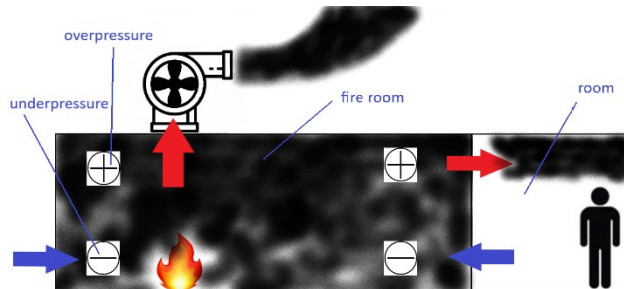

Figure 40: Application of a smoke control system that (still) creates an overpressure at the top of the fire room in the event of a fire

Based on the above, it is interesting to investigate which parameters most influence the pressure difference in the fire room.

Therefore, suppose a constant inlet opening (i.e. $A \times C_d = \text{constant}$) as well as a constant temperature of the supply air (i.e. $\rho = \text{constant}$) during a fire test using a smoke control system. Then it can be deduced from Equation (1) that during the course of the fire test, the following equation applies at the location of the inlet opening:

$$\frac{V_1^2}{\Delta p_1} = \frac{V_2^2}{\Delta p_2} \leftrightarrow \frac{V_1}{V_2} = \sqrt{\frac{\Delta p_1}{\Delta p_2}}$$

with:

- V_1 constant volume flow rate through the inlet opening if no fire source is present (= extraction flow rate) [m^3/s]
- Δp_1 pressure difference associated with V_1 [Pa]
- V_2 volume flow rate through the inlet opening during the fire test [m^3/s]
- Δp_2 pressure difference associated with V_2 [Pa]

Based on the above, the pressure difference during the fire test can be calculated as follows:

$$\frac{\Delta p_1}{\Delta p_2} = \left(\frac{V_1}{V_2}\right)^2 \leftrightarrow \Delta p_2 = \left(\frac{V_2}{V_1}\right)^2 \Delta p_1 \quad (2)$$

Base on this equation, it can be concluded that the pressure difference during a fire test depends on the volume flow rate through the inlet opening, which varies during the fire test.

Now still needs to be determined what can influence the volume flow rate through the inlet opening during the fire test. To determine this, it is assumed that the mass of air brought into the fire room (= m_{in}) approximately equals to the outgoing mass of air (= m_{out}), as shown below:

$$m_{in} \approx m_{out} \leftrightarrow V_{in}\rho_{in} \approx V_{out}\rho_{out} \leftrightarrow V_{in} \frac{353}{T_{in}} \approx V_{out} \frac{353}{T_{out}} \leftrightarrow \frac{V_{in}}{V_{out}} \approx \frac{T_{in}}{T_{out}} \quad (3)$$

with:

m_{in}	mass flow rate of air through the inlet opening [kg/s]
V_{in}	volume flow rate of the air through the inlet opening [m ³ /s]
ρ_{in}	mass density of the air through the inlet [kg/m ³]
T_{in}	air temperature through the inlet opening [K]
m_{out}	mass flow rate of the air through the exhaust opening [kg/s]
V_{out}	volume flow rate of the air through the exhaust opening [m ³ /s]
ρ_{out}	mass density of the air through the exhaust opening [kg/m ³]
T_{out}	air temperature through the exhaust opening [K]

Since the extraction flow rate is assumed to be constant (i.e. $V_{out} = \text{constant}$) then V_{out} can be equated to V_1 (= constant volume flow rate) in the Equation (2). Moreover, it can also be said that V_{in} can be equated with V_2 since both relate to the volume flow rates through the inlet opening.

On this basis, Equation (2) can be rewritten as follows:

$$\Delta p_2 = \left(\frac{V_2}{V_1}\right)^2 \Delta p_1 \rightarrow \Delta p_2 = \left(\frac{V_{in}}{V_{out}}\right)^2 \Delta p_1$$

or also

$$\Delta p_2 \approx \left(\frac{T_{in}}{T_{out}}\right)^2 \Delta p_1 \quad (4)$$

From this last equation it can be deduced that the pressure difference during a fire also depends on the temperature in the exhaust opening (note: the temperature is expressed in Kelvin and not Celsius!).

The higher the temperature of the air in the exhaust opening, the smaller the pressure difference.

The above theoretical explanation is explained below by means of two simulations (one with a fire in the room and one without a fire).

The basic configuration for the simulations is a rectangular compartment (length x width x height: 8 m x 10 m x 2.5 m), provided with a fire source (if applicable), one exhaust opening in the ceiling and three inlet openings at the bottom of the wall as shown in the figure below:

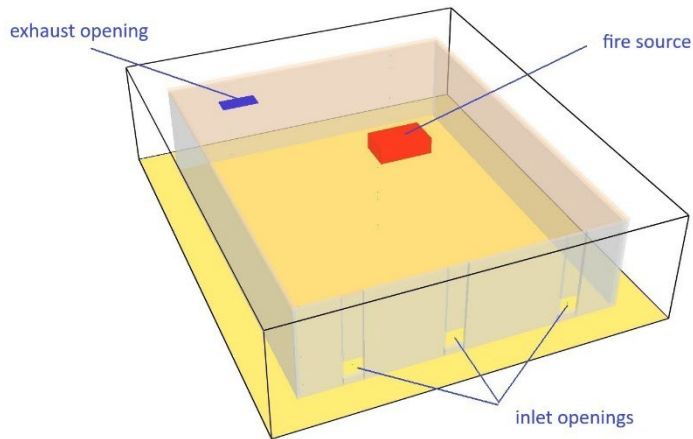

Figure 41: Basic simulation configuration – theoretical explanation

During these simulations, the following assumptions were made:

- The Heat Release Rate (Heat Release Rate per unit area: 500 kW/m²) is based on a medium αt^2 curve (i.e. $\alpha = 0.0117$ kW/s²) with a maximum Heat Release Rate of 800 kW, as shown in the figure below:

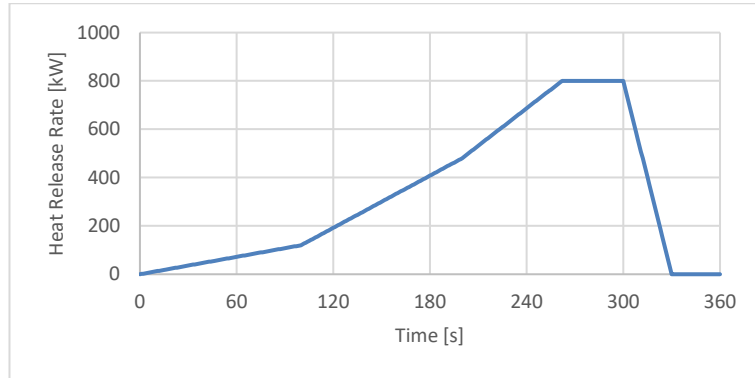

Figure 42: Heat Release Rate (max. 800 kW)

The above curve has been specifically chosen to demonstrate the influence of a growing fire, but also the influence of a fire that extinguishes very quickly.

- The ambient temperature is 20 °C.
- One exhaust opening (dimensions: 1 m x 0.5 m; extraction flow rate: 3 m³/s) is installed in the ceiling. After 10 seconds, the extraction is activated.
- In the wall, three inlet openings (dimensions: 0.5 m x 0.5 m) are installed at a height of 0.2 m from the floor.
- The distance from the fire source to the nearest wall is 1 m.

The following measurements are made during the simulations:

- Measurements of pressure/temperature at a height of 0.2 m, 1 m, 2 m and 2.4 m.
These measurements were made at a location far away from the fire source (at the "left" inlet opening) and a location near the fire source (at the wall directly opposite the fire).
- Measurements of the volume flow rate through the inlet openings.

The results obtained for the pressure difference (at different heights) at the location of the opening far away from the fire source are shown below (simulations both with and without fire):

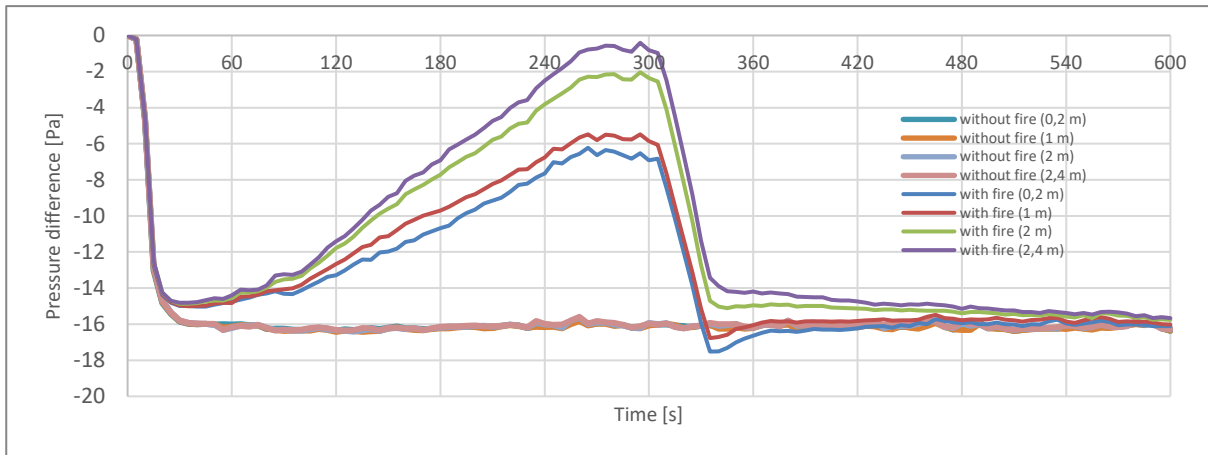

Figure 43: Pressure difference in the fire room (simulations with and without a fire source)

The results obtained for the volume flow rates through the inlet openings are shown below (simulation with fire):

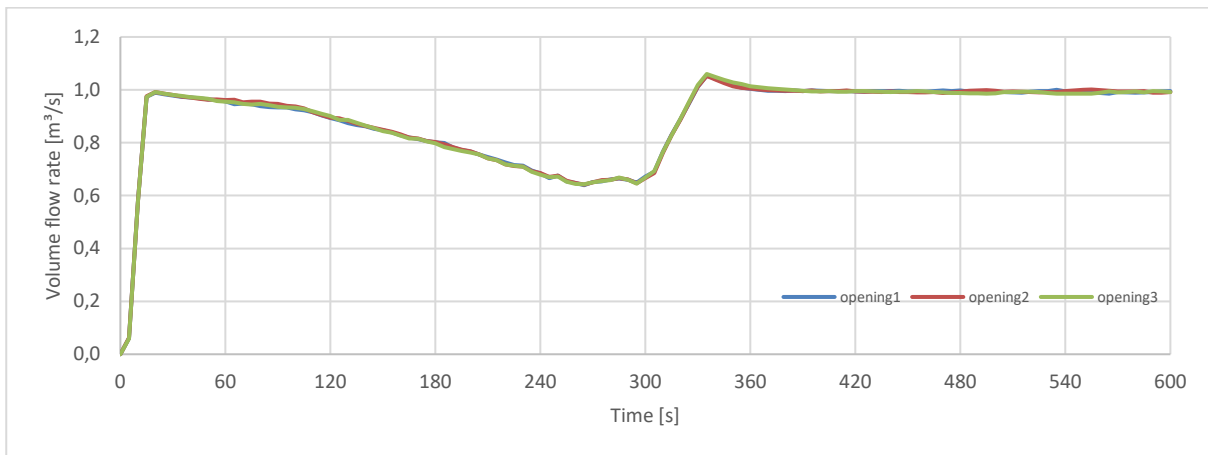

Figure 44: Volume flow rate through the inlet openings (simulation with fire source)

The following can be deduced from the above graphs:

- Already from the activation of the extraction on, there is a difference in size of pressure difference. Without fire in the room, the pressure difference is approx. 16 Pa (underpressure), while the pressure difference in the event of a fire in the room is approx. 15 Pa (underpressure). This is not a big difference, but nevertheless shows that already a few tens of seconds after the start of the fire, the fire has an influence on the pressure development in the room.
- The longer the fire test takes, the more the volume flow rate through the inlet openings decreases in the event of a fire in the room. This is only logical since the temperature in the room increases, and thus also the temperature in the exhaust opening (see also Equation [4]). As soon as the fire is completely out (i.e. Heat Release Rate = 0 kW), the volume flow rate through the inlet opening very quickly amounts to the original volume flow rate (i.e. without the presence of a fire in the room).

- The pressure difference in the room without fire is almost independent of the height. In the event of a fire in the room, the size of the underpressure depends on the height. This also makes sense since the temperature at the top of the room is higher than the temperature at the bottom of the room.
- At the end of the test (i.e. when the fire is completely extinguished) there is no longer any difference in pressure difference between the two simulations. This is because all the heat present in the room has been removed and the temperature of the fan has regained its original air temperature.

The graphs above are based on measurements at the location of the inlet opening. If we look at the pressure differences on the wall directly opposite the fire source and compare them with those obtained above, we get the graph below (only for measurements at a height of 2 m and 2.4 m):

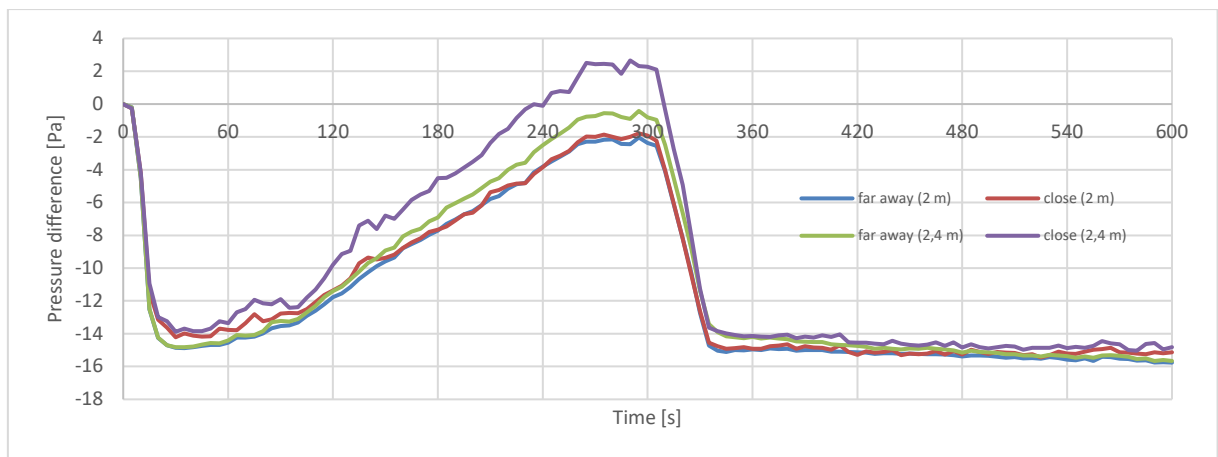

Figure 45: Pressure difference in the room (far away from or close to the fire source)

Therefore, if only the pressure differences far away from the fire source are considered, an underpressure is present over the entire height (see Figure 43). This would imply that no smoke propagation is possible in that zone.

However, if we look close to the fire, it is striking that the pressure difference there at a height of 2.4 m can create an overpressure (see Figure 45).

This higher overpressure is due to the ceiling jet generated by the fire source as shown below:

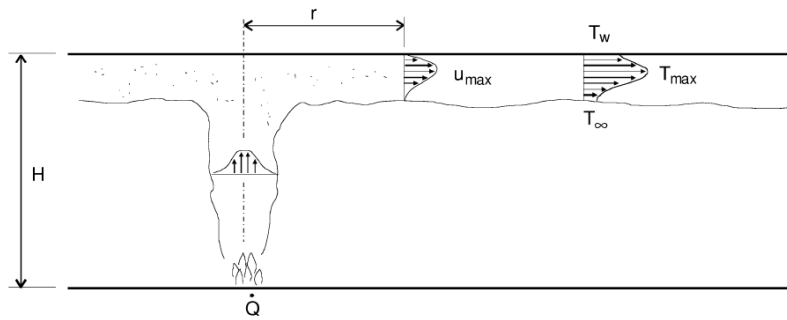

Figure 46: Higher temperatures near the ceiling as a result of the ceiling jet [5]

This ceiling jet creates higher temperatures and higher velocities just below the ceiling, with the latter decreasing as the distance to the fire source increases.

If a wall is close enough to the fire source, an increase in the pressure difference will manifest itself there. Due to this additional pressure difference (approx. 4 to 5 Pa), it is possible that an overpressure can be obtained there, so that smoke propagation at that location (= at a height of 2.4 m) is possible. All this while in all other places of the room an underpressure is present at that same height.

The influence of a ceiling jet on the pressure difference is therefore mainly situated in the upper zone of the fire room (i.e. approx. top 50 cm of the height) since the pressure differences from 2 m (and lower) are similar for the two different locations of measurements (see also Figure 45). This was also observed during the large-scale fire tests.

5.2.3 Basic configuration and assumptions

Unless otherwise specified, the basic configuration for the additional simulations to investigate the potential impact of modified parameters on the efficiency of the smoke control system is a rectangular compartment (length x width x height: 16 m x 10 m x 2.5 m) with the following characteristics:

- a fire at one of the following locations:
 - location A: in the corner of the fire room (i.e. as far away as possible from the air flow between the inlet openings and the exhaust openings);
 - location B: in the middle of the fire room;
 - location C: just before (or just below) the exhaust opening;
 - location D: just in front of (or just below) an inlet opening;
 - with the exception of location B, the distance from the fire source to the wall is approx. 1 m;
- three inlet openings (dimensions (width x height) per opening: 0.5 m x 0.5 m);
 - either at the bottom of the wall: the bottom of the inlet openings is 0.2 m above the floor;
 - or in the ceiling;
 - the inlet openings are located directly opposite the exhaust opening;
- an exhaust opening (dimensions (width x height): 1 m x 0.5 m):
 - either at the top of the wall: the top of the exhaust opening is 0.2 m below the ceiling;
 - or in the ceiling.

In the graphs of this section, the locations of the openings are presented as follows:

- wall – wall (*ww*): the inlet openings are located at the bottom of the wall, the exhaust opening is at the top of the (standing) wall;
- wall – ceiling (*wc*): the inlet openings are located at the bottom of the wall, the exhaust opening is in the ceiling;
- ceiling – ceiling (*cc*): the inlet openings are located in the ceiling, the exhaust opening is located in the ceiling.

The basic configuration is shown schematically in the figure below:

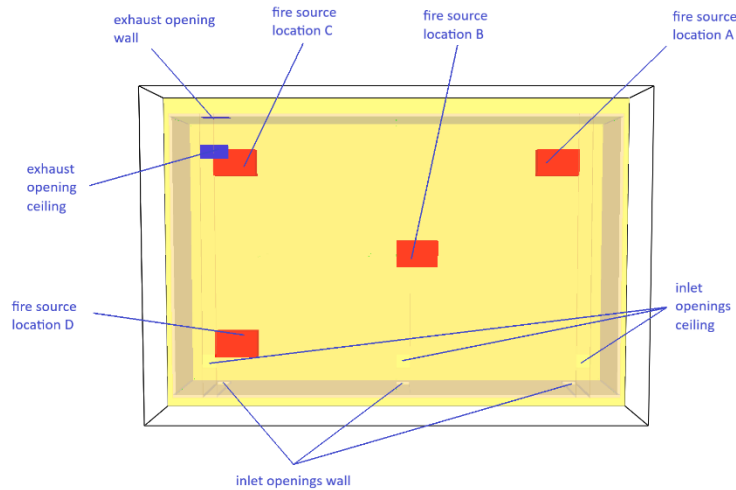

Figure 47: Basic configuration simulations - Preventing the spread of smoke

During these simulations, the following assumptions are made:

- The Heat Release Rate (Heat Release Rate per unit area: 500 kW/m²) is a medium αt^2 curve (i.e. $\alpha = 0.0117$ kW/s²) with a maximum Heat Release Rate of 800 kW or 1600 kW, as shown in the figure below:

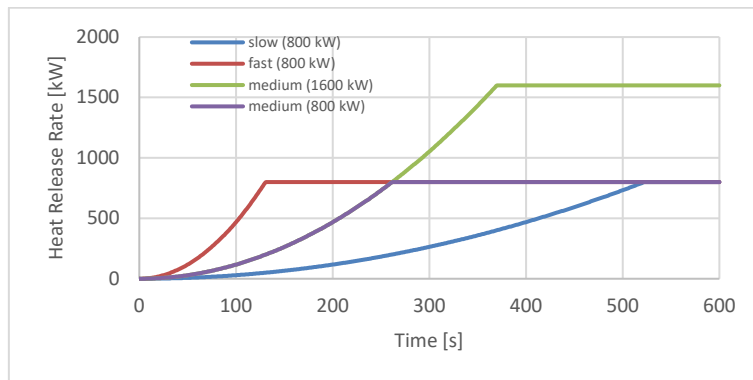

Figure 48: Medium αt^2 curve with maximum Heat Release Rate of 800 kW or 1600 kW

As can be deduced from the figure above, the medium αt^2 curve with a maximum Heat Release Rate of 800 kW is topped after 262 seconds, while with a maximum Heat Release Rate of 1600 kW it is topped after 370 seconds.

At the maximum Heat Release Rate of 800 kW, the influence of a slow αt^2 curve (i.e. $\alpha = 0.00293$ kW/s²; topped at 523 seconds) and a fast αt^2 curve (i.e. $\alpha = 0.0469$ kW/s²; topped at 131 seconds) is also examined (see also § 5.2.4.3).

- All simulations are carried out with actual openings in the compartment, i.e. no pressure zones have been used in FDS. The latter is mainly applied when the dimensions of the opening are significantly smaller than the cell size. There are at least 5 cells per dimensions of the opening.
- Since actual openings in the compartment are used, it is important to have an estimate of the coefficient of contraction of the openings (i.e. C_d). In this study, this value was determined based on both Equation (1) and the results of the CFD simulations (i.e. measured volume flow rate and pressure difference). This shows that for the applied inlet openings in the simulations a value of approx. 0.77 to 0.82 is obtained, i.e. $C_{d,FDS} = 0.77$ to 0.82 .
- The Heat Release Rate per unit area is set at 500 kW/m^2 . This value can be found in the literature for design fires in places where a large fire load is present.
- The smoke control system is presented as an opening at the boundaries of the fire room through which a predetermined extraction flow rate flows. Thus there is no use of a ductwork as it will be applied in reality.

In addition, the extraction flow rate is set constant, i.e. the extraction flow rate here does not depend on the pressure difference present in the fire room. In reality though, this is the case and the extraction flow rate can/will be affected by this pressure difference. This influence will, however, be taken into account when determining the design parameters of the smoke control system.

The following measurements are made during the simulations:

- Measurements of the pressure difference at a height of 0.2 m, 1 m, 2 m and 2.4 m.

These measurements were made at various locations in the fire room. When displaying the results, however, only the values of a "reference point" will be shown.

This reference point is considered to be the average value (at a certain height) obtained for the entire room and is located far enough from the fire source. As described in § 5.2.2 the pressure difference near the fire source will be a bit higher at the top of the fire room because of the ceiling jet.

Unless otherwise stated, the pressure difference of the reference point is measured at a height of 2.4 m, as it is assumed that there may be openings up to that height (e.g. ventilation ducts).

Clarification:

- By 'initial pressure difference' the pressure difference upon activating the extraction flow rate is meant.
 - By 'final pressure difference' the pressure difference that is obtained after the Heat Release Rate has reached its maximum is meant. If the Heat Release Rate decreases again at that time, the 'final pressure difference' can also be considered as the 'minimum pressure difference'.
 - 'Pressure difference curve' refers to the curve between the initial pressure difference and the final pressure difference.
- Measurements of volume flow rates through the inlet openings.
- In the graphs below, the total volume flow rate through the inlet openings is always shown.
- Measurements of the average air temperature over a height of the upper 40 cm of the fire room and over the full height of the fire room.

The air temperature results displayed are the average values measured over the last 50 seconds of the simulation time.

The results of the top 40 cm are especially important to check whether a fire spread in the rest of the fire room through this warm air layer is possible.

5.2.4 Simulations

5.2.4.1 Influence of the location of the inlet openings and the exhaust openings and the location of the fire source

During these simulations, the influence of the location of the (inlet and exhaust) openings and the location of the fire source on the (final) pressure difference is investigated.

During these simulations, the maximum Heat Release Rate (medium αt^2 curve) is set to 800 kW.

The extraction flow rate is 5 m³/s.

The dimensions (width x height) of each inlet opening are 0.5 m x 0.5 m.

The locations of the (inlet and exhaust) openings are *ww* (wall - wall), *wc* (wall - ceiling) and *cc* (ceiling - ceiling).

The results of the average air temperature in the upper 40 cm of the fire room and those of the average air temperature in the entire fire room are shown in the table below:

Average air temperature in the fire room (only upper 40 cm)				
Location openings	Location fire source			
	A (in the corner)	B (in the middle)	C (at the exhaust)	D (at the inlet)
wall – wall (<i>ww</i>)	162 °C	160 °C	109 °C	150 °C
wall – ceiling (<i>wc</i>)	159 °C	153 °C	72 °C	148 °C
ceiling – ceiling (<i>cc</i>)	159 °C	151 °C	43 °C	132 °C
Average air temperature in the fire room (full height)				
Location openings	Location fire source			
	A (in the corner)	B (in the middle)	C (at the exhaust)	D (at the inlet)
wall – wall (<i>ww</i>)	102 °C	104 °C	66 °C	87 °C
wall – ceiling (<i>wc</i>)	100 °C	99 °C	49 °C	85 °C
ceiling – ceiling (<i>cc</i>)	88 °C	85 °C	32 °C	95 °C

From the table above can be deduced that the lowest air temperatures in the fire room are obtained in case of fire location C. This is logical since the fire source is located just below (or just before) the (only) exhaust opening in the fire room. As a result, the heat from the fire source is immediately removed, so that the air in the fire room will heat up less compared to the other locations of the fire source.

From this it can also be concluded that the temperature in the exhaust opening in case of fire location C will be the highest compared to the other fire source locations considered.

The results of the total volume flow rate through the inlet openings and the pressure difference at the reference point (at a height of 2.4 m) are shown below in the case of the location of the openings *ww* (wall – wall):

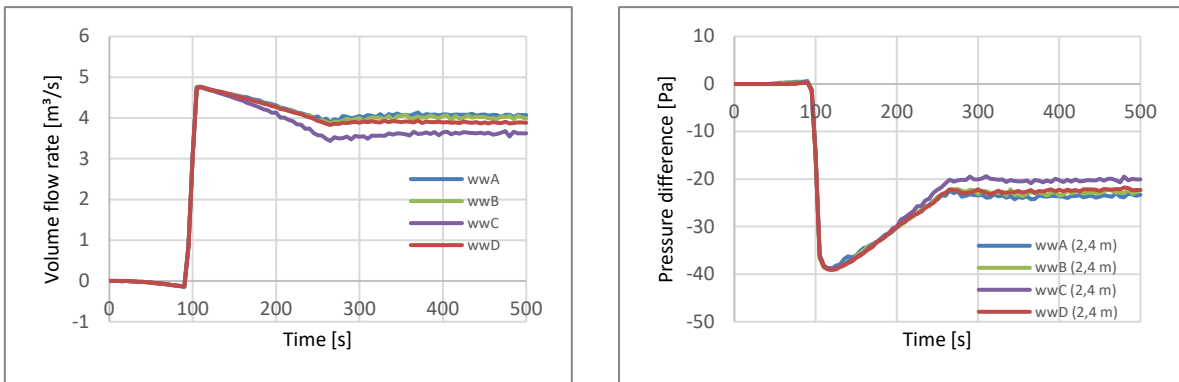
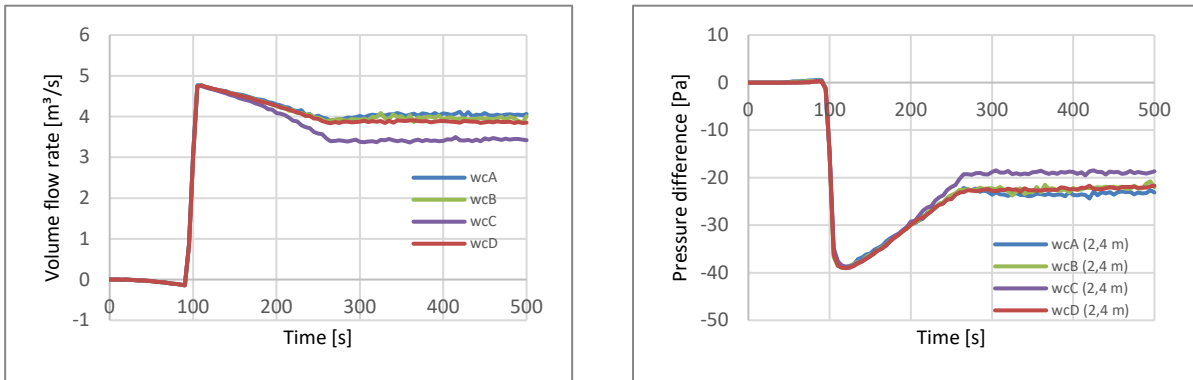

Figure 49: Influence of the location of the fire source (location A, B C or D) at the same locations of the openings, i.e. wall – wall (*ww*)

From the graphs above can be clearly deduced that the lower the volume flow rate, the smaller the (final) pressure difference (compare *wwA* and *wwC* in the graphs above). This makes sense given the ratio between the two as stated in § 5.2.2 (Equation (1)).

This can also be determined in the other simulations with other locations of the openings as shown in the graphs below:



Location openings *wc*

Location openings *wc*

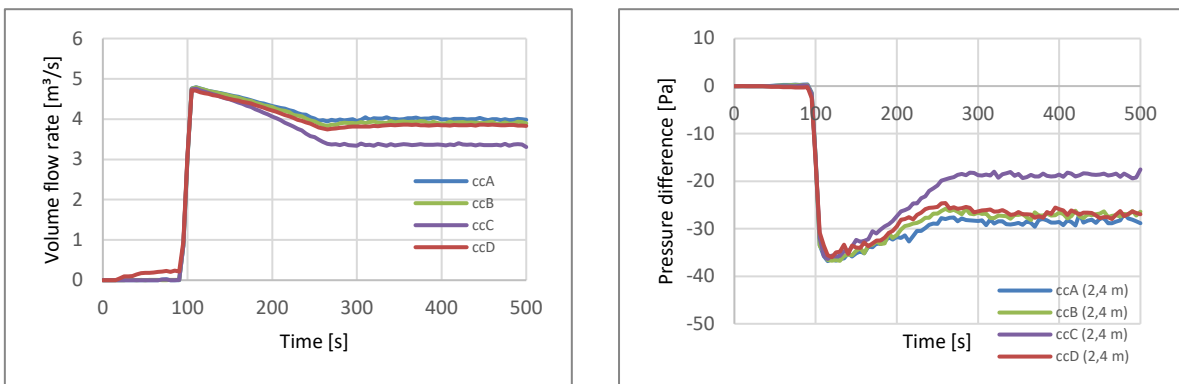

Location openings *cc*

Location openings *cc*

Figure 50: Influence of the location of the fire source (location A, B C or D) at the same locations of the openings, i.e. wall – ceiling (*wc*) or ceiling – ceiling (*cc*)

If we only look at the influence of the location of the openings in relation to a fixed fire source location, we obtain the graphs below for the fire source location A (in the corner of the fire room - far away from an air flow between the inlet opening and the exhaust opening):

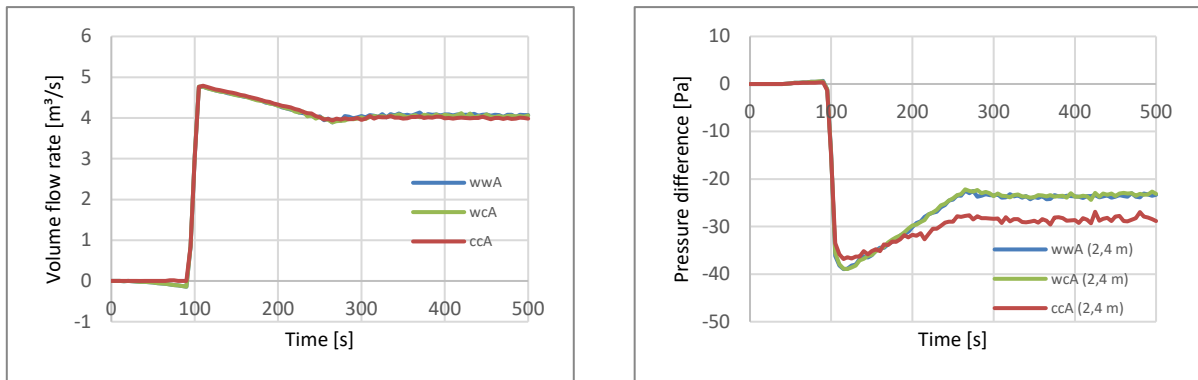

Figure 51: Influence of the location of the fire source (location A) at different locations of the openings, i.e. wall – wall (ww), wall – ceiling (wc) or ceiling – ceiling (cc)

The attentive reader has of course noticed that the earlier conclusion drawn regarding the ratio between the volume flow rate and the (final) pressure difference in the graphs above does not apply here. In these graphs, the volume flow rate is the same in the case of all three different locations of the openings, which would assume that the (final) pressure difference will also be the same in that case.

From the above (right) graph, however, there is a clear difference in the pressure difference (compare *wwA* (or *wcA*) with *ccA*).

For the very attentive reader, however, the above observation is not so surprising since the ratio between the volume flow rate and the pressure difference only applies at the location of the inlet opening (see § 5.2.2).

This implies that for the locations *wwA* (inlet opening in the wall) and *wcA* (inlet opening in the wall) the pressure difference must be displayed at a height of approx. 0.2 m (position of the inlet opening) rather than at a height of approx. 2.4 m. For the location *ccA* (inlet in ceiling) the pressure difference can be applied at a height of 2.4 m.

Note:

The location of the pressure difference measurement described above is not completely correct in order to apply Equation (1). For example, on the one hand, a height of 2.5 m should be taken for the inlet opening in the ceiling (and not 2.4 m) and on the other hand for the inlet opening in the wall, the pressure difference depends on the height (and therefore is not constant).

However, the measurements at a height of 0.2 m and 2.4 m are used, as they are closest to the actual location.

If the pressure difference for the fire source location A is displayed at the location of the height of the inlet openings, the following graphs are obtained:

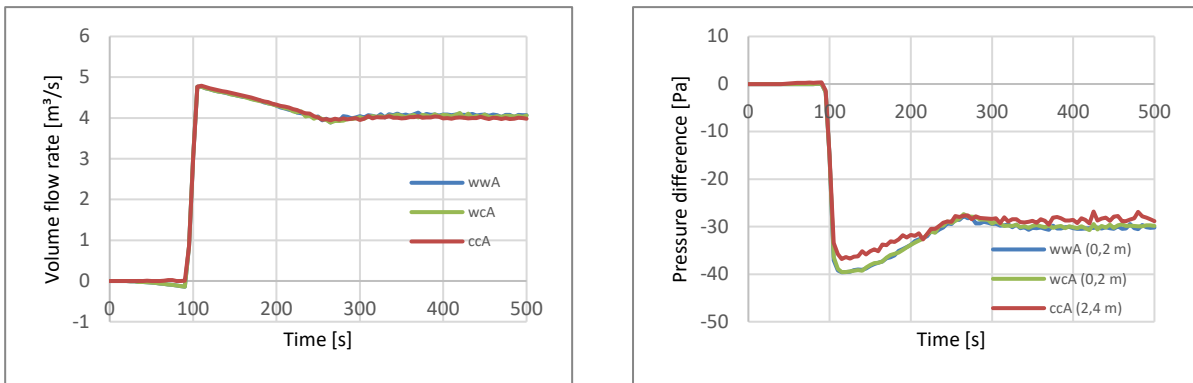

Figure 52: Influence of the location of the fire source (location A) at different locations of the openings, i.e. wall – wall (ww), wall – ceiling (wc) or ceiling – ceiling (cc)

From these graphs, the ratio between the volume flow rate and the (end) pressure difference is more in line with the predetermined ratio between the two, i.e. the (end) pressure differences are also approximately the same for the three locations of openings.

If we only look at the influence of the location of the openings in relation to the fire location C (near the exhaust opening), we obtain the graphs below:

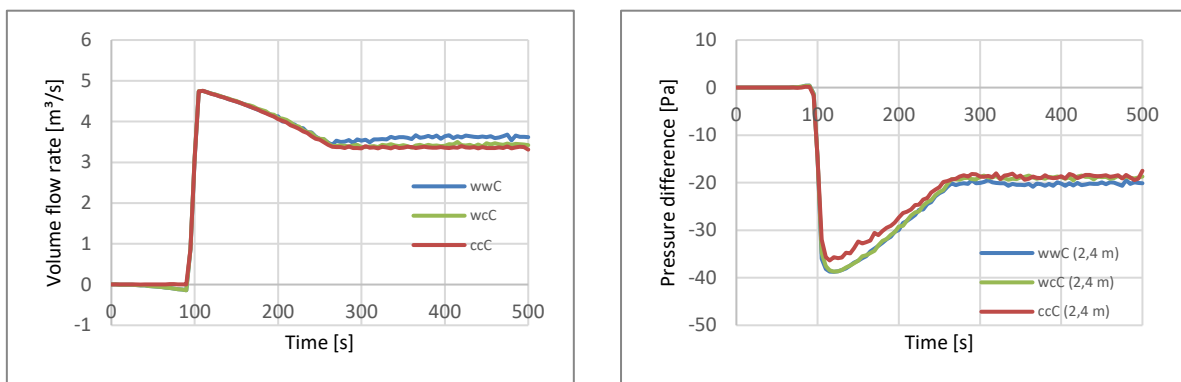

Figure 53: Influence of the location of the fire source (location C) at different locations of the openings, i.e. wall – wall (ww), wall – ceiling (wc) or ceiling – ceiling (cc)

From the graphs above can be deduced that the difference in (final) pressure difference at the various locations of openings is not that big compared to the one obtained for the fire location A.

Additional note:

In all the above simulations, there is no difference in volume flow rate through the inlet openings, i.e. the volume flow rate through each inlet is the same. In addition, all inlet openings are applied at the same height. This is done because it makes it "easy" to investigate the ratio between the volume flow rates and the pressure differences.

In practice, this will not be the case in some situations:

- the velocity at the inlet openings present in the same duct is never the same (if the section of the duct is unchanged and there are no control valves), the velocity at the first inlet opening will always be higher than at the second one etc.;
- the inlet openings may be at different heights, e.g. an opening in the ceiling and an opening at the bottom of a wall;
- the inlet openings can be located in several walls.

For this reason, several simulations were also carried out in which the three vertical inlet openings were "spread out" differently, as explained below:

- three inlet openings (at the same height) in three different walls;
- an inlet opening at the bottom of the wall and the other two at the top of an adjacent wall;
- three inlet openings in the same wall but at different heights.

The results of these CFD simulations are not included in this study, but it can be reported that the influence of the different locations of the inlet openings on the (final) pressure difference is of the same order of magnitude as those obtained during the other simulations.

Conclusions:

Based on the simulations carried out, the following conclusions can be made:

- The influence of the location of the (inlet and exhaust) openings, as well as the location of the fire source on the pressure difference is not negligible. The simulations have shown that the value of the (end) pressure difference can differ up to approx. 50 %.

The "best" result for the pressure difference (i.e. the highest value of the (final) pressure difference) is obtained in case of the location of the openings cc, i.e. both inlet openings and exhaust openings in the ceiling. By "best" result is meant that a pressure difference is obtained that is closest to the initial pressure difference.

- The "best" results for the pressure difference are obtained if the fire source is as far as possible from the air flow between the inlet opening and the exhaust openings, i.e. fire location A. In this case, the highest air temperatures have been obtained in the fire room.

The "worst" results for pressure difference are obtained when the fire source is as close as possible to the exhaust opening, i.e. fire location C. In this case, the lowest air temperatures in the fire room have been obtained.

That is why, for the following CFD simulations, only the fire locations A and C are selected.

5.2.4.2 Influence of the Heat Release Rate

During these simulations, the influence of the Heat Release Rate on the (final) pressure difference is investigated.

During the large-scale fire tests, a maximum Heat Release Rate of 800 kW is applied. Of course, in practice, more flammable material may be available, whereby the maximum fire capacity can be higher due to fire expansion.

During these simulations, the maximum Heat Release Rate (medium αt^2 curve) is set to 1600 kW (see Figure 48).

The extraction flow rate is 5 m³/s.

The dimensions (width x height) of each inlet opening are 0.5 m x 0.5 m.

The locations of the fire are A and C.

The locations of the openings are *wc* (wall – ceiling) and *cc* (ceiling – ceiling).

The results of the average air temperature in the upper 40 cm of the fire room and those of the average air temperature in the entire fire room are shown in the table below:

Average air temperature in the fire room (only upper 40 cm)				
Location openings	Location fire source A (in the corner)		Location fire source C (at the exhaust)	
	800 kW	1600 kW	800 kW	1600 kW
wall – ceiling (<i>wc</i>)	159 °C	253 °C	72 °C	196 °C
ceiling – ceiling (<i>cc</i>)	159 °C	255 °C	43 °C	186 °C
Average air temperature in the fire room (full height)				
Location openings	Location fire source A (in the corner)		Location fire source C (at the exhaust)	
	800 kW	1600 kW	800 kW	1600 kW
wall – ceiling (<i>wc</i>)	100 °C	144 °C	49 °C	113 °C
ceiling – ceiling (<i>cc</i>)	88 °C	145 °C	32 °C	105 °C

From the table above can be logically deduced that the air temperatures in the fire room are higher if the Heat Release Rate is bigger.

The results of the total volume flow rate through the inlet openings and the pressure difference at the reference point (at a height of 2.4 m) for the location of the openings wc, are shown below:

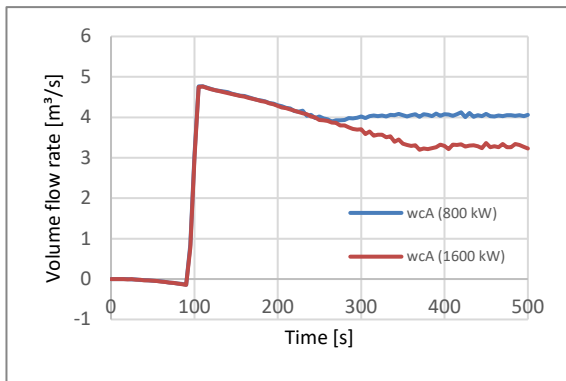

Location of the fire source A

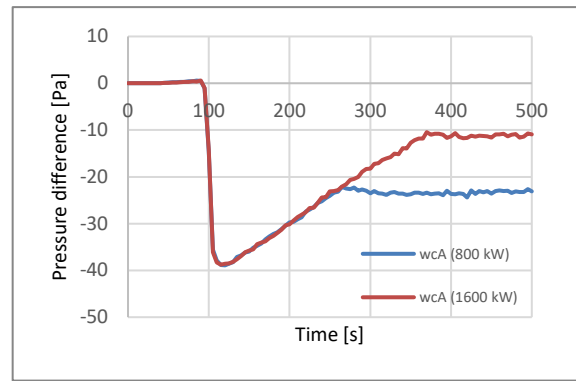

Location of the fire source A

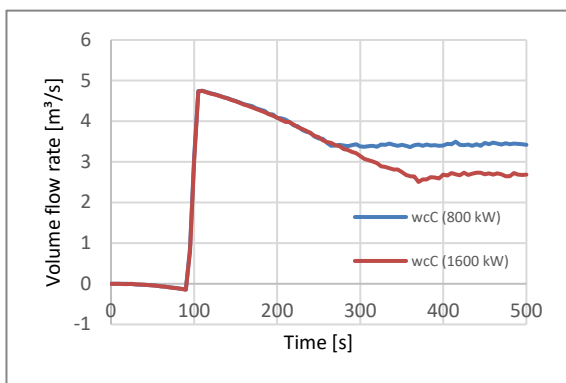

Location of the fire source C

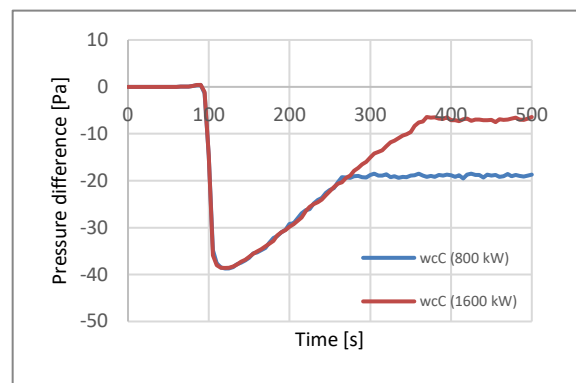

Location of the fire source C

Figure 54: Influence of the Heat Release Rate at the same location of the openings, i.e. wall – ceiling (wc) and fire location A and C

From the graphs above can be deduced that an increase in the Heat Release Rate results in a lower final pressure difference. The "slope" of the pressure difference curve is approximately the same for both Heat Release Rate, but is topped at a different time for both, i.e. when the Heat Release Rate curve reaches its maximum.

The slope of the pressure difference curve is not perfectly linear but certainly not quadratic like the Heat Release Rate curve.

The results of the total volume flow rate through the inlet openings and the pressure difference at the reference point (at a height of 2.4 m) for the location of the openings cc, are shown below:

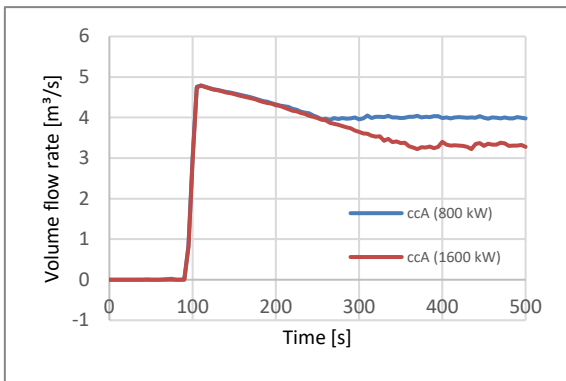

Location of the fire source A

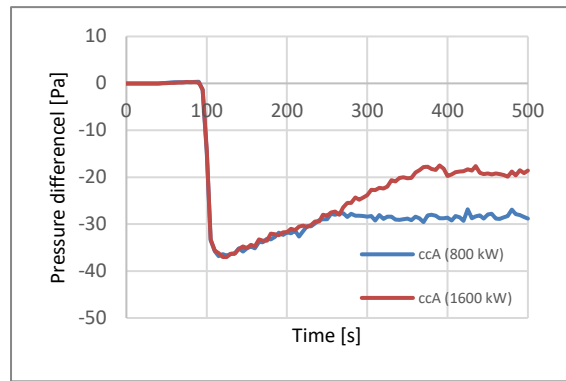

Location of the fire source A

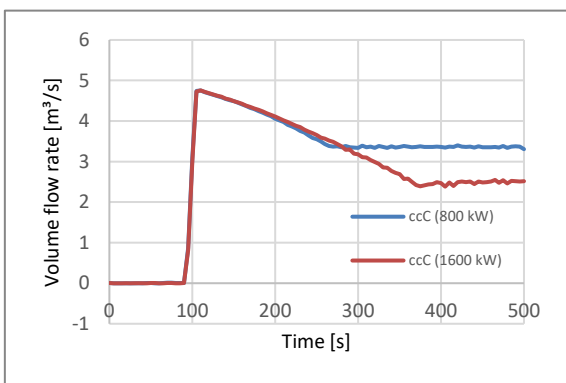

Location of the fire source C

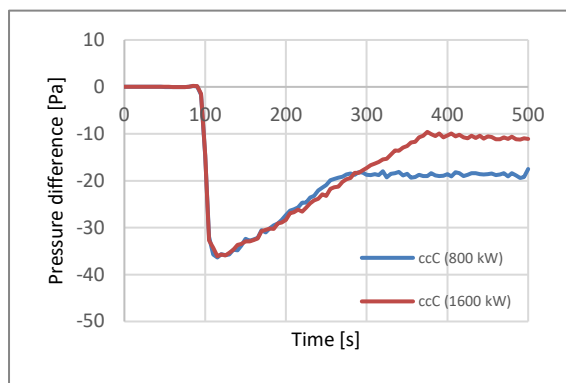

Location of the fire source C

Figure 55: Influence of the Heat Release Rate at the same location of the openings, i.e. ceiling – ceiling (cc) and fire location A and C

Conclusions:

Based on the simulations carried out, the following conclusions can be made:

- An increase in the Heat Release Rate means that the development of the pressure difference curve is topped at a later time. In these simulations this is logical since the maximum value of the Heat Release Rate is obtained at a later time. This conclusion therefore only applies if the Heat Release Rate per unit area as well as the curve are the same for both Heat Release Rate.
- Here too, the "best" result for the pressure difference (i.e. the highest value of the pressure difference) is obtained in case of the location of openings cc, i.e. both inlet openings and exhaust openings in the ceiling.

5.2.4.3 Influence of the αt^2 curve

During these simulations, the influence of the αt^2 curve on the (final) pressure difference is investigated.

During the previous simulations, a medium αt^2 curve (i.e. $\alpha = 0.0117 \text{ kW/s}^2$) is applied. In these simulations, the slow αt^2 curve (i.e. $\alpha = 0.00293 \text{ kW/s}^2$) as well as the fast αt^2 curve (i.e. $\alpha = 0.0469 \text{ kW/s}^2$) are applied.

During these simulations, the maximum Heat Release Rate (slow and fast αt^2 curve) is set to 800 kW (see also Figure 48).

The extraction flow rate is $5 \text{ m}^3/\text{s}$.

The dimensions (width x height) of each inlet opening are $0.5 \text{ m} \times 0.5 \text{ m}$.

The location of the fire is A.

The location of the openings is wc (wall – ceiling).

The results of the average air temperature in the upper 40 cm of the fire room and those of the average air temperature in the entire fire room are shown in the table below:

Location of the fire source A - Heat Release Rate 800 kW			
Average air temperature in the fire room (only upper 40 cm)			
Location openings	slow αt^2 curve	medium αt^2 curve	fast αt^2 curve
wall – ceiling (wc)	150 °C	159 °C	162 °C
Average air temperature in the fire room (full height)			
Location openings	slow αt^2 curve	medium αt^2 curve	fast αt^2 curve
wall – ceiling (wc)	93 °C	100 °C	101 °C

From the table above can be deduced that the air temperatures in the fire room are very similar. Of course, the slow αt^2 curve has the lowest temperatures as this curve reaches its maximum at a much later time.

The results of the total volume flow rate through the inlet openings and the pressure difference at the reference point (at a height of 2.4 m) for the location of the openings *wc*, are shown below:

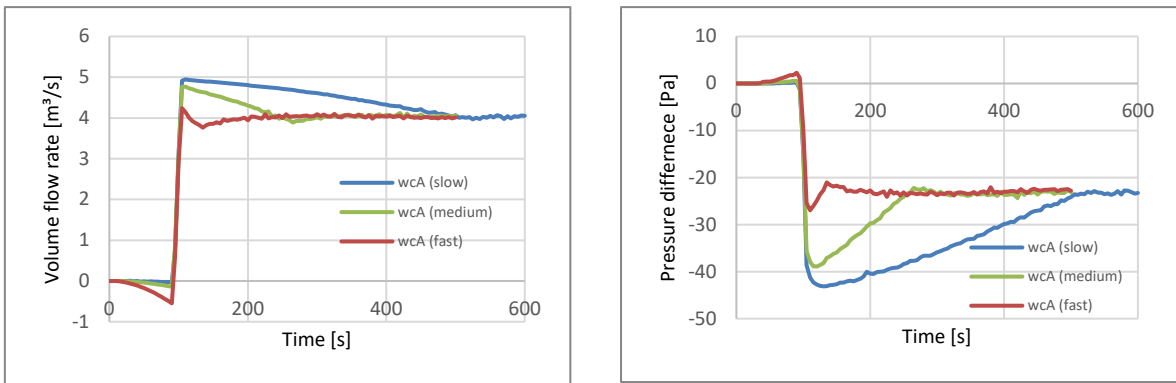

Figure 56: Influence of the αt^2 curve at the same location of the openings, i.e. wall – ceiling (*wc*) and fire location A

Conclusions:

Based on the simulations carried out, the following conclusions can be made:

- The αt^2 curve has (almost) no influence on the final pressure difference. Only the moment when the final pressure difference is obtained, is different for the three types of αt^2 curve studied.
- The "slope" of pressure difference curve is different for the types of αt^2 curve studied. The final pressure difference is reached fastest in the case of a fast αt^2 curve (and the slowest in the case of a slow αt^2 curve).

5.2.4.4 Influence of the dimensions of the inlet openings

During these simulations, the influence of the dimensions of the inlet openings on the (final) pressure difference is investigated.

During these simulations, the maximum Heat Release Rate (medium αt^2 curve) is set to 800 kW or 1600 kW (see also Figure 48).

The extraction flow rate is 5 m³/s.

The dimensions (width x height) of each inlet opening are 0.5 m x 0.5 m or 1 m x 0.5 m.

The locations of the fire are A and C.

The locations of the openings are *wc* (wall – ceiling) and *cc* (ceiling – ceiling).

The results of the average air temperature in the upper 40 cm of the fire room and those of the average air temperature in the entire fire room (for a Heat Release Rate of 800 kW) are shown in the table below:

Heat Release Rate 800 kW				
Average air temperature in the fire room (only upper 40 cm)				
Location openings	Location fire source A (in the corner)		Location fire source C (at the exhaust)	
	0.75 m ²	1.50 m ²	0.75 m ²	1.50 m ²
wall – ceiling (<i>wc</i>)	159 °C	160 °C	72 °C	59 °C
ceiling – ceiling (<i>cc</i>)	159 °C	161 °C	43 °C	40 °C
Average air temperature in the fire room (full height)				
Location openings	Location fire source A (in the corner)		Location fire source C (at the exhaust)	
	0.75 m ²	1.50 m ²	0.75 m ²	1.50 m ²
wall – ceiling (<i>wc</i>)	100 °C	80 °C	49 °C	39 °C
ceiling – ceiling (<i>cc</i>)	88 °C	84 °C	32 °C	29 °C

From the table above can be deduced that, for both fire locations, a larger area of the inlet openings (especially in the case of the inlet opening at the bottom of the wall) results in a more pronounced decrease in the average air temperature compared to the inlet opening in the ceiling.

The dimensions of the inlet opening have a negligible influence on the air temperature of the upper 40 cm for fire location A.

The results of the average air temperature in the upper 40 cm of the fire room and those of the average air temperature in the entire fire room (for a Heat Release Rate of 1600 kW) are shown in the table below:

Heat Release Rate 1600 kW				
Average air temperature in the fire room (only upper 40 cm)				
Location openings	Location fire source A (in the corner)		Location fire source C (at the exhaust)	
	0.75 m²	1.50 m²	0.75 m²	1.50 m²
wall – ceiling (<i>wc</i>)	253 °C	250 °C	196 °C	201 °C
ceiling – ceiling (<i>cc</i>)	255 °C	252 °C	186 °C	153 °C
Average air temperature in the fire room (full height)				
Location openings	Location fire source A (in the corner)		Location fire source C (at the exhaust)	
	0.75 m²	1.50 m²	0.75 m²	1.50 m²
wall – ceiling (<i>wc</i>)	144 °C	133 °C	113 °C	111 °C
ceiling – ceiling (<i>cc</i>)	145 °C	144 °C	105 °C	88 °C

From the table above, the same conclusion can be taken as for the fire location A, i.e. that a larger area of the inlet openings (especially in the case of the inlet opening at the bottom of the wall) results in a more pronounced decrease in the average air temperature compared to the inlet opening in the ceiling.

However, in the case of fire location C, this is now reversed in case of a higher Heat Release Rate.

The dimensions of the inlet opening have a negligible influence on the air temperature of the upper 40 cm for fire location A.

Since it has been shown in § 5.2.4.2 that the Heat Release Rate only results in a later topping of the pressure difference curve, only the Heat Release Rate of 1600 kW is shown in the graphs below.

The results of the total volume flow rate through the inlet openings and the pressure difference at the reference point (at a height of 2.4 m) for the locations of the openings *wc* and *cc*, are shown below:

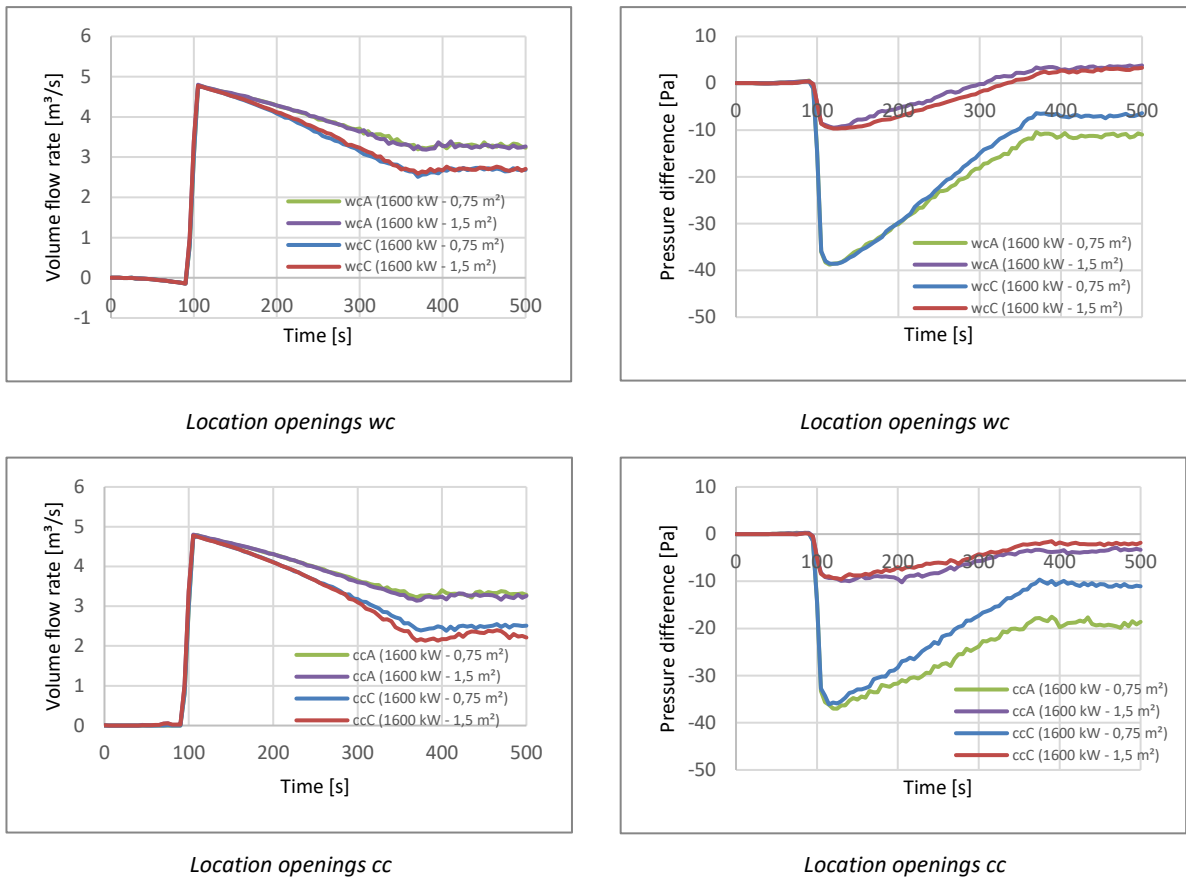

Figure 57: Influence of the dimensions of the inlet openings at the same locations of the openings, i.e. wall – ceiling (*wc*) and ceiling – ceiling (*cc*) and fire source locations A and C

From the graphs above can be deduced that increasing the dimensions initially results in a lower initial pressure difference. This makes sense given the ratio of the aerodynamic surface area of the gap to the pressure difference as discussed in Equation (1).

It can also be observed that the "slope" of the pressure difference curve is less steep in the case of a larger area of the inlet. This implies that the influence of the fire source (i.e. the curve of the Heat Release Rate) is smaller when the inlet openings are larger. To a certain extent this is logical since the slope of the overpressure due to a fire (in a room without a smoke control system) is also less steep when the openings in the room are bigger.

Finally, it can be concluded that with larger inlet openings an overpressure is obtained if the inlet is at the bottom of the wall and still an underpressure if the inlet is in the ceiling. Even at the location of the fire source (where there is influence of the ceiling jet) in this configuration (i.e. ceiling – ceiling (*cc*)) no overpressure is noticed (these results are not shown in this study).

Conclusions:

Based on the simulations carried out, the following conclusions can be made:

- When the dimensions of the inlet openings are bigger, the maximum underpressure in the fire room is always smaller (in case of a constant extraction flow rate). However, due to this bigger dimensions, the slope of the pressure difference curve is less steep.
- Due to a low initial value of the underpressure in the fire room, it is possible that – in case of a high Heat Release Rate – the underpressure can turn into an overpressure since the slope of the pressure difference curve remains approximately constant.

In addition, it is possible that in the event that the inlet opening is located at the bottom of the wall, this results in an overpressure, while if the inlet opening is in the ceiling, the underpressure in the room is always maintained.

- When the dimensions of the inlet opening are small, only a small extraction flow rate is required to obtain an underpressure. However, this small opening can have a major influence on the slope of the pressure difference curve, so that overpressure can be obtained (faster) over time.

5.2.4.5 Influence of the extraction flow rate

During these simulations, the influence of the extraction flow rate on the (final) pressure difference is investigated.

During these simulations, the maximum Heat Release Rate (medium αt^2 curve) is set to 800 kW (see also Figure 48).

The extraction flow rate is 2 m³/s, 3 m³/s, 4 m³/s, 5 m³/s or 6 m³/s.

The dimensions (width x height) of each inlet opening are 0.5 m x 0.5 m.

The location of the fire is A.

The location of the openings is wc (wall – ceiling).

The results of the average air temperature in the upper 40 cm of the fire room and those of the average air temperature in the entire fire room are shown in the table below:

Location of the fire source A – Heat Release Rate 800 kW					
Average air temperature in the fire room (only upper 40 cm)					
Location openings	2 m ³ /s	3 m ³ /s	4 m ³ /s	5 m ³ /s	6 m ³ /s
wall – ceiling (wc)	198 °C	179 °C	168 °C	159 °C	140 °C
Average air temperature in the fire room (full height)					
Location openings	2 m ³ /s	3 m ³ /s	4 m ³ /s	5 m ³ /s	6 m ³ /s
wall – ceiling (wc)	110 °C	95 °C	93 °C	100 °C	93 °C

From the table above can be deduced that an increase in the extraction flow rate does not always result in a lower average air temperature in the fire room. This depends on the airflow in the fire room and can be different in each configuration. It is therefore not possible to draw a clear conclusion with regard to this.

The results of the total volume flow rate through the inlet openings and the pressure difference at the reference point (at a height of 2.4 m) for the location of the openings *wc*, are shown below:

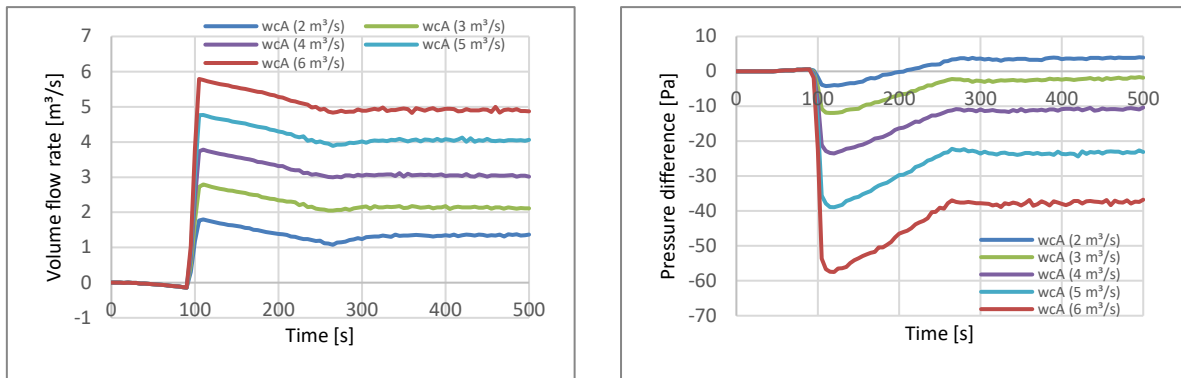

Figure 58: Influence of the extraction flow rate at the same location of the openings, i.e. wall – ceiling (*wc*) and fire source location A

From the graphs above can be deduced that a lower extraction flow rate results in a lower initial pressure difference. This is logical given the ratio between the volume flow rate (= extraction flow rate) and the pressure difference as discussed in § 5.2.2.

It can also be observed that the "slope" of the pressure difference curve is less steep in the case of a lower extraction flow rate. In contrast to § 5.2.4.4, where the influence of the dimensions of the inlet openings has been investigated, this slope does not depend on the surface area of the inlet opening but on the velocity through the inlet opening.

For all extraction flow rates, the pressure difference curve is topped when the maximum value of the Heat Release Rate is reached.

If extraction flow rates are too low, it is possible that an overpressure is obtained (see extraction flow rate 2 m³/s).

The above simulations are carried out with a constant extraction flow rate. Now suppose that the extraction flow rate varies in time, as shown below:

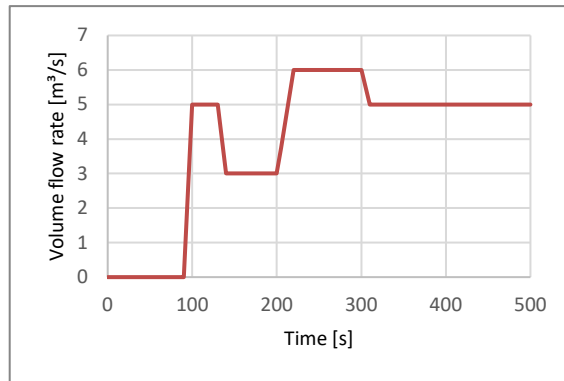

Figure 59: Variable extraction flow rate

After 90 seconds we start with an extraction flow rate of 5 m³/s, subsequently reaching first 3 m³/s and then 6 m³/s. Finally, the original 5 m³/s is again used. The transitions to the other extraction flow rates all take place before the Heat Release Rate reaches its maximum value (i.e. 800 kW at 262 seconds).

The results of the total volume flow rate through the inlet openings and the pressure difference at the reference point (at a height of 2.4 m) for the location of the openings wc, are shown below:

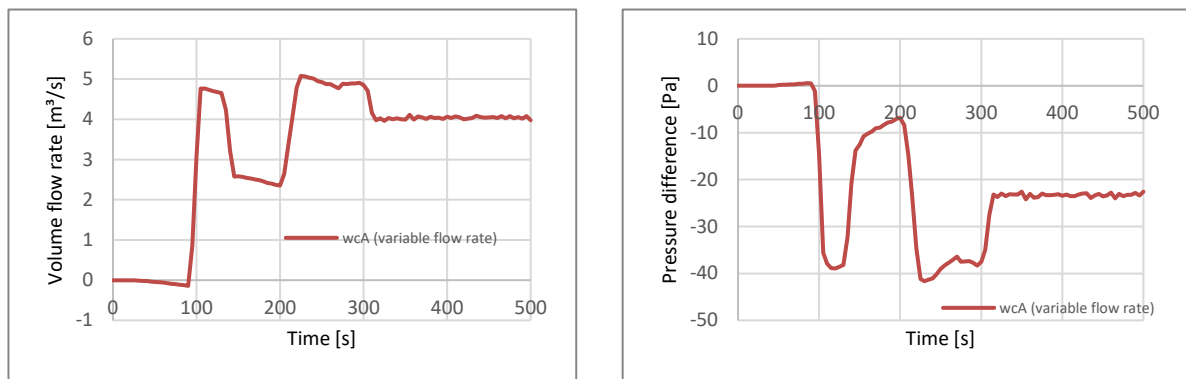

Figure 60: Influence of a variable extraction flow rate at the same location of the openings, i.e. wall – ceiling (wc) and fire source location A

From the graphs above can be deduced that the curve of the volume flow rate through the inlet openings is very similar to the curve of the imposed extraction flow rate. The value of the volume flow rate obviously differs since a temperature increase in the exhaust openings results in a lower volume flow rate through the inlet openings (see § 5.2.2).

As far as the pressure differences are concerned, it can be observed that the pressure difference curve is determined by the imposed extraction flow rates rather than by the Heat Release Rate. At 200 seconds, the Heat Release Rate is still rising but an extraction flow rate of 6 m³/s is activated. At that moment, a huge increase in the value of the underpressure can be observed (and this while the temperature continues to rise).

The above observation becomes clearer when we add the graphs of the extraction flow rates of 3 m³/s, 5 m³/s and 6 m³/s (from Figure 58) in these of the variable extraction flow rate, as shown below:

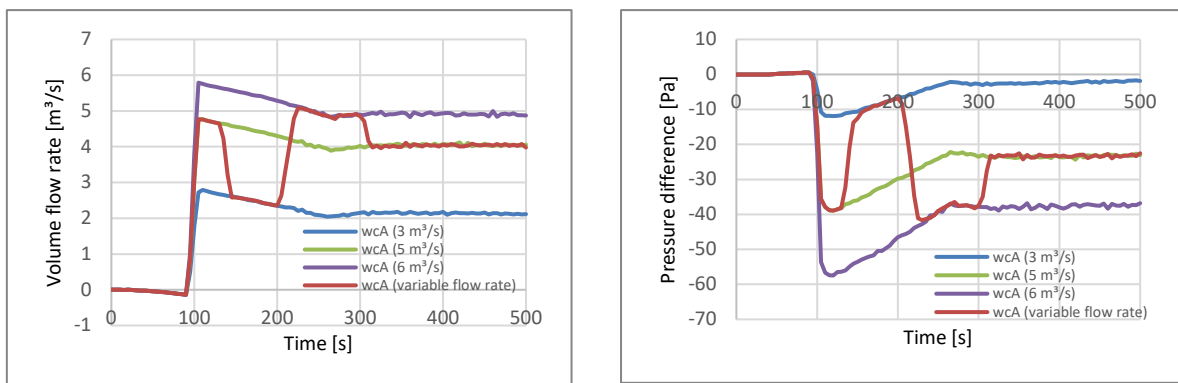

Figure 61: Comparison between the results obtained for a variable and a fixed extraction flow rate at the same location of the openings, i.e. wall – ceiling (wc) and fire source location A

From the graphs above can be deduced that - in case of a varying extraction flow rate - the pressure difference will always follow the curve of the respective extraction flow rate. In other words, the pressure difference adapts very quickly to the new extraction flow rate. This development of pressure difference seems to happen almost independently of the Heat Release Rate.

Conclusions:

Based on the simulations carried out, the following conclusions can be made:

- The "slope" of the pressure difference curve is less steep in case of a lower extraction flow rate. In contrast to § 5.2.4.4, where the influence of the dimensions of the inlet openings has been investigated, this slope is therefore not only dependent on the surface area of the inlet opening but also on the velocity through the inlet opening.
- For all extraction flow rates, the pressure difference curve is topped when the maximum value of the Heat Release Rate is reached.
- The pressure difference curve is determined to a greater extent by the imposed extraction flow rates rather than the Heat Release Rate. In the simulation, for example the Heat Release Rate is still rising at 200 seconds, when an extraction flow rate of 6 m³/s is activated. At that moment, a huge increase in the value of the underpressure can be observed (and this while the temperature continues to rise).

Important note:

The above observation, i.e. the (large) influence of the extraction flow rate on the pressure difference, confirms the suspicion that in Test 3 (Application of a fire screen – completely down) the extraction flow rate was not constant in the initial period of the test (since the aerodynamic surface area of the inlet openings was smaller than that of the exhaust openings).

From the graph of the pressure difference (see § 8.3) it can be deduced that an increase in the pressure difference already starts after approx. 240 seconds, and this while the temperatures everywhere in the room continue to rise until approx. 300 to 330 seconds. If the extraction flow rate was constant, this increase would only occur as soon as the temperatures in the room decrease (see § 8.2). The latter was observed during Test 2 (Application of a fire screen – up to 0.9 m above the ground) during which an increase in the pressure difference was observed at the time when the temperatures in the vicinity of the fire source were decreasing.

5.2.4.6 Influence of the surface area of the fire room

During these simulations, the influence of the surface area of the fire room on the (final) pressure difference is investigated.

During these simulations, the maximum Heat Release Rate (medium αt^2 curve) is set to 800 kW (see also Figure 48).

The extraction flow rate is 5 m³/s.

The surface area of the fire room is 80 m² (small), 160 m² (normal) or 320 m² (large).

The dimensions (width x height) of each inlet opening are 0.5 m x 0.5 m.

The locations of the fire are A and C.

The location of the openings is *wc* (wall – ceiling).

The results of the average air temperature in the upper 40 cm of the fire room and those of the average air temperature in the entire fire room are shown in the table below:

Average air temperature in the fire room (only upper 40 cm)						
Location openings	Location fire source A (in the corner)			Location fire source C (at the exhaust)		
	small (80 m ²)	normal (160 m ²)	large (320 m ²)	small (80 m ²)	normal (160 m ²)	large (320 m ²)
wall – ceiling (<i>wc</i>)	180 °C	159 °C	120 °C	104 °C	72 °C	70 °C
Average air temperature in the fire room (full height)						
Location openings	Location fire source A (in the corner)			Location fire source C (at the exhaust)		
	small (80 m ²)	normal (160 m ²)	large (320 m ²)	small (80 m ²)	normal (160 m ²)	large (320 m ²)
wall – ceiling (<i>wc</i>)	116 °C	100 °C	77 °C	53 °C	49 °C	38 °C

From the table above can be deduced that a smaller volume (= smaller surface area) will always result in higher air temperatures for the fire location A.

In the case of fire location C, the influence on the air temperature is less since most heat is immediately dissipated.

For your information

An additional simulation (fire location A – in the corner) was carried out for the small area of the fire room (= 80 m²) where the maximum Heat Release Rate was 1600 kW instead of the 800 kW described above.

During this simulation, the following air temperatures were obtained:

- average air temperature in the fire room (only upper 40 cm): 316 °C;
- average air temperature in the fire room (full height): 181 °C.

The results of the total volume flow rate through the inlet openings and the pressure difference at the reference point (at a height of 2.4 m) for the location of the openings wc, are shown below:

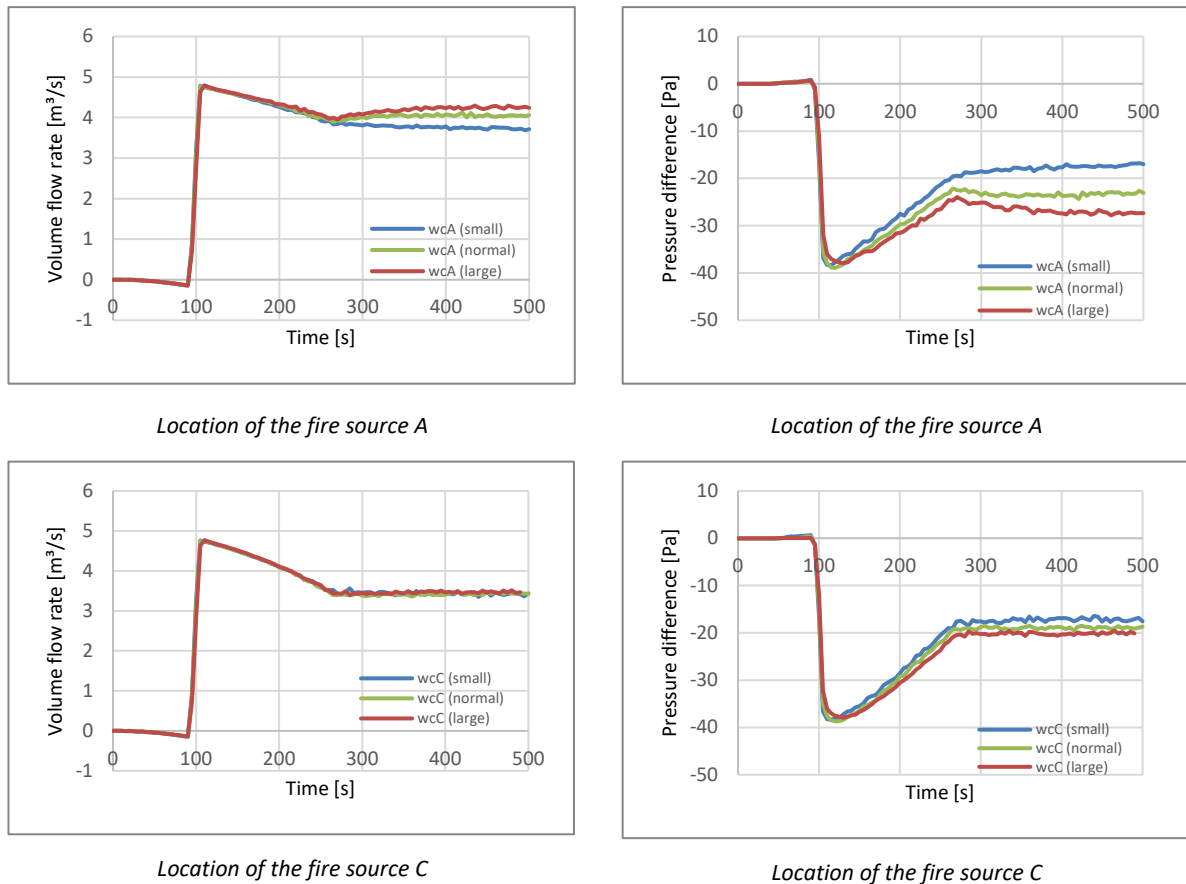

Figure 62: Influence of the area of the fire room at the same location of the openings, i.e. wall – ceiling (wc) and fire source locations A and C

Based on the graphs above, it can be clearly deduced that an increase in the surface area of the fire room will result in higher extraction flow rates (i.e. lower air temperatures), resulting in a higher (final) pressure difference. In addition, it is possible that a fire room that is too small, is not able to dissipate the produced heat on time. The thermal properties of the compartment boundaries obviously play a very important role here, namely the better insulated, the less quickly the heat can be dissipated and therefore the more the extraction flow rate will decrease in value.

Conclusions:

Based on the simulations carried out, the following conclusions can be made:

- The smaller the volume of the fire room, the less blending occurs between the warm air layer and the cold supply air, which increases the air temperature.
- The above conclusion also applies when the height increases. This simulation is not included in this study, but the pressure differences in such a case (i.e. same surface area but bigger height) are similar to the original "normal" configuration.

5.2.5 Conclusions

Based on the simulations carried out, the following conclusions can be made:

- The pressure difference is determined by (the velocity through and the dimensions of) the inlet openings on the one hand and by (the temperature in) the exhaust openings on the other hand, whereby the following observations have been determined:
 - The higher the velocity (= volume flow rate/aerodynamic surface area) through the inlet opening, the higher the initial pressure difference (= the pressure difference after activating the extraction flow rate).
 - The higher the temperature in the exhaust openings, the smaller the final pressure difference (= pressure difference at the time of the maximum value of the Heat Release Rate).
 - The smaller the dimensions of the inlet openings, the steeper the pressure difference curve.
 - The higher the velocity through the inlet openings, the steeper the pressure difference curve.
- The Heat Release Rate curve has almost no influence on the final pressure difference, only on the slope of the pressure difference curve.
- The pressure difference curve is influenced more by the extraction flow rate than by the Heat Release Rate.
- The "best" results for the pressure difference (i.e. the highest value of the (final) pressure difference) are obtained when the inlet openings and the exhaust openings are located in the ceiling. By "best" result is meant that a pressure difference is obtained that is closest to the initial pressure difference.

5.2.6 Concept parameters

Taking into account the conclusions described above and those concerning the ratio between the inlet openings and the exhaust openings (see § 4.4.6), the following design parameters of the smoke control system have been drawn up in order to achieve an underpressure in a fire room:

- The height of the fire room is min. 2.5 m.
- The aerodynamic surface area of the inlet opening(s) is greater than or equal to the aerodynamic surface area of the exhaust opening(s), i.e. $A_{in} \times C_{d,in} \geq A_{out} \times C_{d,out}$.

This ensures that the efficiency of the smoke control system is not negatively affected.

- The extraction flow rate is between 2.5 m³/s and 5 m³/s.

A pressure control system ensures that a predetermined pressure difference is obtained by varying the extraction flow rate in function of the measured pressure difference in the fire room.

The predetermined pressure difference is - 5 Pa (underpressure) at a height of the top of the openings in the room. This ensures that there is always underpressure at lower lying openings.

The value of the predetermined pressure difference is kept low so that sudden increases in extraction flow rates are avoided when openings are created.

If a pressure control system is used, the minimum extraction flow rate is 2.5 m³/s. As soon as the smoke control system is activated, an extraction flow rate of 2.5 m³/s is initiated. The maximum extraction flow rate is 5 m³/s.

If no pressure control system is used, the extraction flow rate is 5 m³/s.
- The velocity at the inlet opening is max. 5 m/s (at the initial extraction flow rate).

This ensures that the efficiency of the smoke control system is not negatively affected by excessive pressure losses at the inlet openings.

In the case of application of the pressure control system, the maximum extraction flow rate will only be reached when the temperature in the exhaust openings is already high. At that time (i.e. at maximum or higher extraction flow) the velocity through the inlet opening is lower than the velocity without fire, what makes that the additional pressure losses (due to the higher extraction flow rates) at the inlet opening are limited.
- The minimum aerodynamic surface area of the inlet opening(s) is 0.5 m², i.e. $A_{in} \times C_{d,in} = \text{min. } 0.5 \text{ m}^2$.

This ensures – initially – that the influence of the fire source on the pressure difference curve is minimized, i.e. the slope of the pressure difference is less steep.

An additional reason for this minimum value is the link between the minimum extraction flow rate (= 2.5 m³/s) and the maximum velocity through the inlet opening (= 5 m/s).

The above simulations are carried out with one exhaust opening. If multiple exhaust openings are used, the average temperature in the exhaust openings will be lower as there is more blending of the warm air layer with the colder supply air. A lower temperature in the exhaust openings results in a higher final pressure difference.

The openings of a ventilation system can hereby possibly be used passively as inlet openings for the smoke control system.

- The Heat Release Rate of the fire source is max. 1.5 MW.

The above-mentioned design parameters have been established in case of a maximum Heat Release Rate of approx. 1.5 MW. This maximum value can only be guaranteed if one of the following conditions is met:

- Either by limiting the amount of fire load:

The additional CFD simulations have shown that the maximum value of the Heat Release Rate (kW) determines the minimum pressure difference obtained. Not only a limitation in fire load (MJ/m²), as applied in Appendix 6 of the Basic Standards (Royal Decree of 07/07/94 and subsequent amendments), can therefore be applied to quantify the permitted amount of fire load, but it is therefore best to also take into account the Heat Release Rate per unit area (kW/m²) of the fire source.

For your information: The fire load of the fire source (maximum HRR: 800 kW; surface area: approx. 1.6 m²) during this study is approx. 260 MJ/m².

- Or by using an automatic extinguishing system:

If the smoke control system must first be activated in order to remove any smoke already present, the velocity at the exhaust openings shall be low enough so as not to adversely affect the proper functioning of the automatic extinguishing system.

However, the combination of a smoke control system and an automatic extinguishing system has not been further elaborated in this study, but it is obvious that the extraction flow rates described above will be smaller in case of the application of an automatic extinguishing system. In the latter case, i.e. after activation of the automatic extinguishing system, the smoke control system will therefore mainly be used to make the fire room smoke-free as fast as possible.

5.3 SMOKE CONTROL SYSTEM USING A FIRE SCREEN UP TO A HEIGHT OF MAX. 1 M

5.3.1 Introduction

Test 2 (Application of a fire screen up to 0.9 m above the ground) has shown that it is possible to create a smoke-free evacuation route in the fire room using a smoke control system and a fire screen.

In preparation for the large-scale fire test, the extraction flow rate was determined in function of the known Heat Release Rate (i.e. the sofa) and a predetermined smoke-free height (which is approx. 0.5 m higher than the height of the opening under the fire screen). The available design standards for SHEV systems can be used for this, since the test set-up is, as it were, an application of the combination of a SHEV system and a fire screen, but on a much smaller scale. The velocity under the fire screen was kept low during the fire test in order to obtain a clear separation between the smoke layer and the ambient air.

In order to obtain the same smoke-free height, in case of a higher Heat Release Rate than that applied during the large-scale fire test, the extraction flow rate must be increased on the one hand, but on the other hand there must also be sufficiently large exhaust openings (with low volume flow rates) in order to avoid plug-holing. As a result of the latter – in which ambient air rather than smoke is discharged – the smoke layer could descend further than the bottom of the fire screen. Since the velocity under the fire screen decreases as a result of the higher air temperature in the exhaust opening (see also § 5.2.5), the smoke layer can get under the fire screen, thus causing smoke to propagate in the created evacuation route. The latter is of course detrimental to the evacuation.

When drawing up the design parameters of this application of the smoke control system, it was therefore determined to guarantee a minimum velocity under the fire screen so that no air flow from the fire room to the created evacuation route is possible. Based on the preceding paragraph (i.e. § 5.2) where it has been established that the velocity at the inlet opening decreases when the air temperature in the exhaust opening increases, it is thus important that a minimum velocity is guaranteed during the entire fire test. In this section it will be investigated whether an initial velocity of 1.25 m/s under the fire screen is sufficient for this.

The large-scale fire test has shown that this application of the smoke control system is effective for the fire source in question, the specific ventilation conditions, the predetermined extraction flow rate and the dimensions of the fire room.

During these additional CFD simulations, the influence of the following varying parameters (with regard to the large-scale fire tests) on the efficiency of this application of the smoke control system is investigated:

- the width (and height) of the opening under the fire screen;
- the extraction flow rate;
- the Heat Release Rate;
- the location of the inlet openings in relation to the opening under the fire screen;
- the dimensions of the inlet openings;
- the width of the evacuation route;
- the dimensions of the fire room.

5.3.2 Basic configuration and assumptions

The basic configuration for the simulations is a rectangular compartment (length x width x height: 16 x 10 m x 2.5 m) with the following characteristics:

- a fire source in the middle of the fire room;
- an opening under the fire screen (width: 2.5 m, 5 m or 10 m; height: 0.8 m or 1 m);
- an evacuation route (width: 2 m or 4 m);
- at least two inlet openings (of different dimensions) in the ceiling of the evacuation route, where the openings may be located at the opening under the fire screen and/or at a distance from it;
- two exhaust openings (dimensions: 0.5 m x 0.5 m or 1 m x 1 m), which are located in the ceiling.

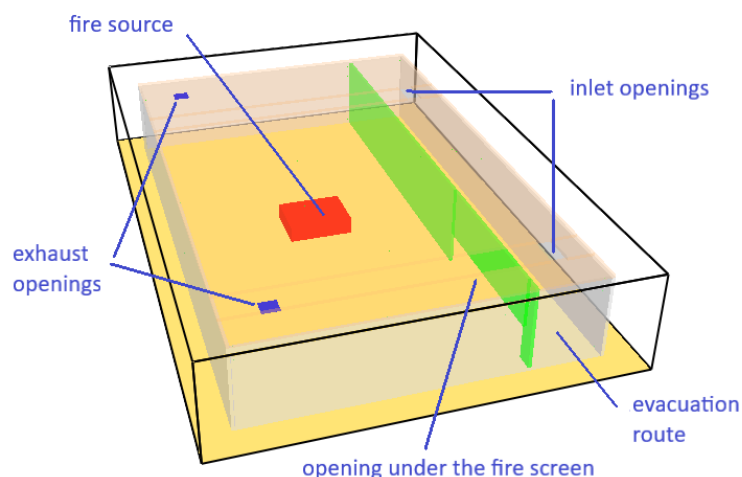

Figure 63: Basic configuration simulation – application of a fire screen up to a height of max. 1 m

During these simulations, the following assumptions were made:

- The Heat Release Rate (Heat Release Rate per unit area: 500 kW/m²) is a medium αt^2 curve (i.e. $\alpha = 0.0117$ kW/s²; topped after 370 seconds) with a maximum Heat Release Rate of 1600 kW (see also Figure 48).
- The ambient temperature is 20 °C.
- All simulations are carried out with actual openings in the compartment, i.e. no pressure zones have been used in FDS. The latter is mainly applied when the dimensions of the opening are significantly smaller than the cell size. There are at least 5 cells per dimensions of the opening.
- Since actual openings in the compartment are used, it is important to have an estimate of the coefficient of contraction of the inlet openings (i.e. C_d). In this study, this value was determined based on both Equation (1) and the results of the CFD simulations (i.e. measured volume flow rate and pressure difference). This shows that for the applied inlet openings in the simulations a value of approx. 0.77 to 0.82 is obtained, i.e. $C_{d,FDS} = 0.77$ to 0.82.
- The Heat Release Rate per unit area is set at 500 kW/m². This value can be found in the literature for design fires in places where a large fire load is present.
- The smoke control system is presented as an opening at the boundaries of the fire room through which a predetermined extraction flow rate flows. Thus there is no use of a ductwork as it will be applied in reality.

In addition, the extraction flow rate is set constant, i.e. the extraction flow rate here does not depend on the pressure difference present in the fire room. In reality though, this is the case and the extraction flow rate can/will be affected by this pressure difference. This influence will, however, be taken into account when determining the design parameters of the smoke control system.

The following measurements are made during the simulations:

- Measurements of the volume flow rate under the fire screen.

The measurements of the volume flow rate under the fire screen show in which direction the air flow will move under the fire screen. If an air flow manifests itself from the fire room to the evacuation route, this may indicate smoke propagation to the evacuation route. This airflow should be avoided at all times.

The volume flow rate results displayed are the average values measured over the last 100 seconds of the simulation time.

- Measurements of the pressure difference (in the fire room) at a height of 0.2 m, 1 m, 2 m and 2.4 m.

The measurements of the pressure difference have been carried out but are not shown in this section as they are – under similar conditions (i.e. Heat Release Rate, extraction flow rate, inlet openings) – in the same order of those measured during the additional CFD simulations in § 5.2.

- Measurements of the average air temperature over a height of the upper 40 cm of the fire room and over the full height of the fire room.

The measurements of the average air temperatures have been carried out but are not shown in this section as they are – under similar conditions (i.e. Heat Release Rate, extraction flow rate, inlet openings) – in the same order of those measured during the additional CFD simulations in § 5.2.

5.3.3 Simulations

During these simulations, it is investigated which parameters can have an influence on the air flow under the fire screen.

During these simulations, the maximum Heat Release Rate (medium αt^2 curve) is set to 1600 kW.

An overview of the results of the volume flow rates through the opening under the fire screen of the simulations carried out is shown in the table below:

Reference simulation	Extraction flow rate [m ³ /s]	Inlet opening				Opening under screen (w x h) [m x m]	Volume flow rate as to the evacuation route [m ³ /s]	
		Surface area [m ²] Position with respect to the opening under the screen		Distance to opening under screen [m]	Velocity [m/s]		out	in
		under	next to					
Screen1	5	0.5	0.5	8	5	2.5 x 1	2.931	0.003
Screen2	5	0.5	0.5	7.5	5	5 x 0.8	3.026	0.070
Screen3	5	0	0.5 and 0.5	1.5 and 6.5	5	5 x 0.8	2.963	0.009
Screen4	5	0.7	0.7	6.5	3.57	5 x 0.8	3.007	0.037
Screen5	5	0.7	0.7	2.5 and 9	3.57	5 x 0.8	2.824	0.003
Screen6	5	0.7	0.7 and 2	6.5 and 11	1.47	5 x 0.8	2.936	0.010
Screen7	5	1	1	6.5	2.5	5 x 0.8	3.000	0.034
Screen8	6.25	0.5	0.25 and 0.5	1.5 and 6.5	5	5 x 1	4.041	0.112
Screen9	6.25	0.7	1.3	6.5	3.13	5 x 1	3.987	0.043
Screen10	10	0.6 and 0.6	0.8	1.5	5	10 x 0.8	7.463	0.199
Screen11	10	1 and 1	2	1.5	2.5	10 x 0.8	7.318	0.030
Screen12	10	1	3	1.5	2.5	10 x 0.8	7.339	0.015
Screen13	12.5	0.78 and 0.78	0.98	2.8	4.9	10 x 1	10.032	0.317

For your information (different configurations compared to the basic configuration):

Simulation "Screen5" is the same as "Screen4", but where the width of the evacuation route is 4 m instead of 2 m. As a result, the surface area of the fire room is also smaller.

Simulation "Screen6" is the same as "Screen4", but with an opening (2 m²) at the bottom of the wall of the evacuation route.

From the table above it can initially be deduced that there is always a very limited air flow (= volume flow rate) from the fire room to the evacuation route. This airflow is already present at the moment of the activation of the smoke control system and is caused by the fact that it is not possible to create an air flow over the entire (relatively large) area of the opening under the fire screen (i.e. 2.5 m² to 10 m²).

This airflow is therefore independent of the fire source and has as consequence that in the event of the smoke covering the entire fire room, it can flow back to the evacuation route via this air flow. If the volume flow rate of this air flow is small enough, the main air flow (= air flow from the evacuation route to the fire room) will always ensure that the smoke is discharged back to the fire room, so that the evacuation route is kept smoke-free. For example, during the simulations *Screen 8*, *Screen 10* and *Screen 13*, a very short-lived and very small smoke propagation to the evacuation route can be observed, but this smoke is immediately lead back to the fire room so that the evacuation route remains smoke-free.

The size of the airflow from the fire room to the evacuation route is bigger when the distance from the inlet opening to the opening under the fire screen is shorter and also if the velocity at the inlet opening is higher. In both cases, the velocity of the initial airflow at the inlet openings is not distributed sufficiently over the surface of the opening under the fire screen, allowing an air flow from the fire room to the evacuation route.

5.3.4 Conclusions

Based on the simulations carried out, the following conclusions can be made:

- The smaller the velocity at the inlet openings (i.e. the larger the surface area) or the further away the inlet openings are from the opening under the fire screen, the smaller the airflow from the fire room to the evacuation route.
- When starting at a minimum velocity of 1.25 m/s under the fire screen, the spread of smoke to the evacuation route can be avoided. By lowering the fire screen (i.e. reducing the surface area of the opening) the same velocity can be achieved with a lower extraction flow rate than originally anticipated.

The velocity under the fire screen decreases when the air temperature in the exhaust openings increases (see also § 5.2.5).

- The maximum height of the opening under the fire screen is 1 m. This height is predetermined as it becomes difficult for very large areas of the opening to achieve an airflow over the entire surface of the opening.
- It is also possible to realize an underpressure in the fire room. Hereby, the conclusions described in § 5.2.5 apply.

5.3.5 Concept parameters

Taking into account the conclusions described above and those concerning the relationship between the inlet openings and the exhaust openings (see § 4.4.6) the following design parameters of the smoke control system have been established in order to guarantee a smoke-free evacuation route:

- The operating height of the fire room is min. 2.5 m.
- The aerodynamic surface area of the inlet opening(s) is greater than or equal to the aerodynamic surface area of the exhaust opening(s), i.e. $A_{in} \times C_{d,in} \geq A_{out} \times C_{d,out}$.

This ensures that the efficiency of the smoke control system is not negatively affected.

- First the fire screen is lowered, then the smoke control system is activated. The extraction flow rate is determined based on the minimum required velocity under the fire screen.
- The average velocity under the fire screen is min. 1.25 m/s (determined under ambient conditions, i.e. the situation without fire).

This ensures that the remaining minimum velocity under the fire screen is sufficient to continue to guarantee the airflow - over the entire surface under the fire screen - to the fire room.

- The velocity at the inlet opening is max. 5 m/s.

If the inlet is located at the opening under the fire screen or within a distance of less than 1 m (projected horizontally), this velocity is limited to 3 m/s.

As a result, the velocity of the initial airflow at the inlet openings is distributed evenly over the surface of the opening under the fire screen.

The openings of a ventilation system can hereby possibly be used passively as inlet openings for the smoke control system.

- There are at least two inlet openings and at least two exhaust openings, where the distance between two inlet openings is min. 3 m and max. 10 m.
- The height under the fire screen is max. 1 m.

The height under the fire screen is only limited by the presence of any obstacles that prevent the fire screen from descending further. So if possible, the fire screen can be lowered even more in order to be able to apply a lower extraction flow rate at a certain width of the fire screen.

A fire screen that is positioned to a certain height can always be combined with fire screens that go completely down. It is not imperative that all fire screens are applied in the same position.

- The Heat Release Rate of the fire source is max. 1.5 MW.

The above-mentioned design parameters have been established in case of a maximum Heat Release Rate of approx. 1.5 MW. This maximum value can only be guaranteed if one of the following conditions is met:

- Either by limiting the amount of fire load:

The additional CFD simulations have shown that the maximum value of the Heat Release Rate (kW) determines the minimum pressure difference obtained. Not only a limitation in fire load (MJ/m²), as applied in Appendix 6 of the Basic Standards (Royal Decree of 07/07/94 and subsequent amendments), can therefore be applied to quantify the permitted amount of fire load, but it is therefore best to also take into account the Heat Release Rate per unit area (kW/m²) of the fire source.

For your information: The fire load of the fire source (maximum HRR: 800 kW; surface area: approx. 1.6 m²) during this study is approx. 260 MJ/m².

- Or by using an automatic extinguishing system:

If the smoke control system must first be activated in order to remove any smoke already present, the velocity at the exhaust openings shall be low enough so as not to adversely affect the proper functioning of the automatic extinguishing system.

However, the combination of a smoke control system and an automatic extinguishing system has not been further elaborated in this study, but it is obvious that the extraction flow rates described above will be smaller in case of the application of an automatic extinguishing system. In the latter case, i.e. after activation of the automatic extinguishing system, the smoke control system will therefore mainly be used to make the fire room smoke-free as fast as possible.

5.4 CLEAR SEPARATION BETWEEN THE SMOKE LAYER AND THE AMBIENT AIR (= SMOKE-FREE HEIGHT)

5.4.1 Introduction

Test 5 (combination of a smoke control system and a sprinkler system) has shown that with the help of a smoke control system it is possible – in the initial phase of a fire – to achieve a smoke-free height in the fire room. This could be important in case of small fires where there is more smoke development rather than heat production.

This section will investigate under what conditions a clear smoke-free height can be obtained for fires with a small Heat Release Rate.

5.4.2 Basic configuration and assumptions

The basic configuration for the simulations is a rectangular compartment (length x width x height: 8 m x 10 m x 2.5 m), provided with a fire source and one inlet opening in the wall as shown in the figure below:

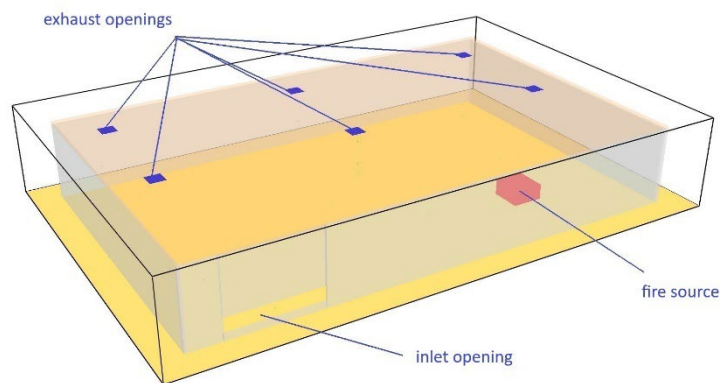

Figure 64: Basic configuration simulation – clear separation between the smoke layer and the ambient air

During these simulations, the following assumptions were made:

- The Heat Release Rate (Heat Release Rate per unit area: 500 kW/m²) is a medium αt^2 curve (i.e. $\alpha = 0.0117$ kW/s²) with a maximum Heat Release Rate of 100 kW or 300 kW as shown in the figure below:

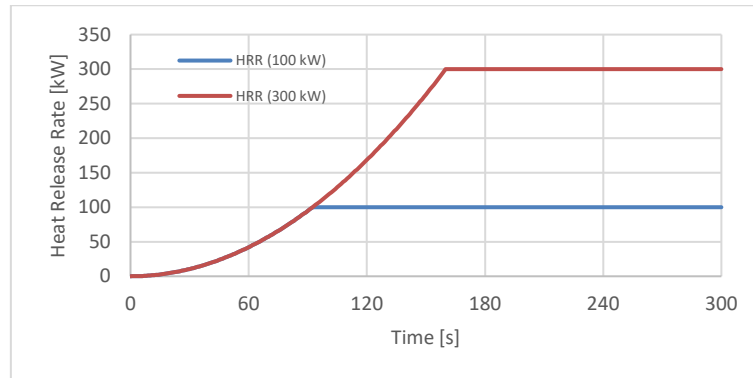

Figure 65: Medium αt^2 curve with maximum Heat Release Rate of 100 kW and 300 kW

As can be deduced from the figure above, the medium αt^2 curve with a maximum Heat Release Rate of 100 kW is topped after 93 seconds, while the one with a maximum Heat Release Rate of 300 kW is topped after 160 seconds.

The fire source is not positioned in front of the opening.

- The ambient temperature is 20 °C.
- The value of the soot yield is set at 0.1, i.e. 0.1 kg of soot is produced in the smoke layer per kg of mass loss of the fuel.
- There are six evenly distributed exhaust openings (dimensions (per opening): 0.5 m x 0.5 m; extraction flow rate per opening: 0.5 m³/s) in the ceiling. The total extraction flow rate is therefore 3 m³/s. After 90 seconds, the extraction is activated.
- The inlet opening (height: 0.5 m) is applied at the bottom of the wall. The width of this opening is 3 m, 6 m or 12 m, so that respective surfaces of inlet openings of 1.5 m², 3 m² and 6 m² will be investigated.

The following measurements are made during the simulations:

- Visibility
- Smoke-free height

The smoke-free height is calculated in FDS based on the temperatures measured at six different positions in the room, with the hereafter displayed value of the smoke-free height being the average of these six values.

5.4.3 Simulations

The results for visibility are shown in the figures below. The degree of visibility is represented by the following ascending colors: red (very good visibility) – yellow – green – blue (very poor visibility).

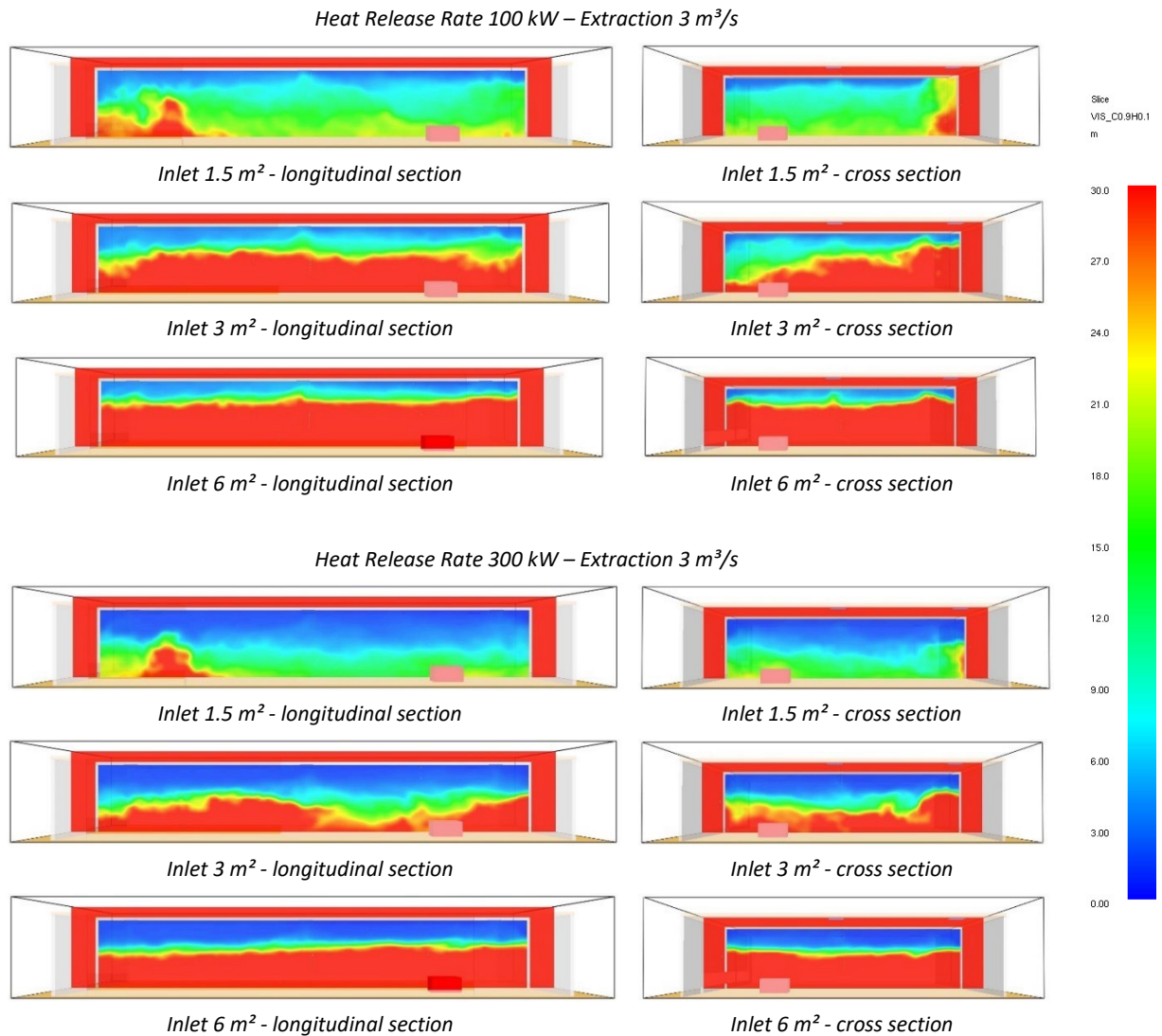

Figure 66: Visibility in case of Heat Release Rate of 100 kW and 300 kW

From the graphs above it is clear that the larger the inlet opening (or the smaller the velocity through the inlet opening), the better a separation between the smoke layer and the ambient air, i.e. a smoke-free height, is obtained.

If the inlet is too small (or the velocity through the inlet opening is too high), a lot of turbulence can be observed in the room and thus the smoke layer is blended with the ambient air, reducing visibility.

The results obtained for the smoke-free height are shown in the graphs below:

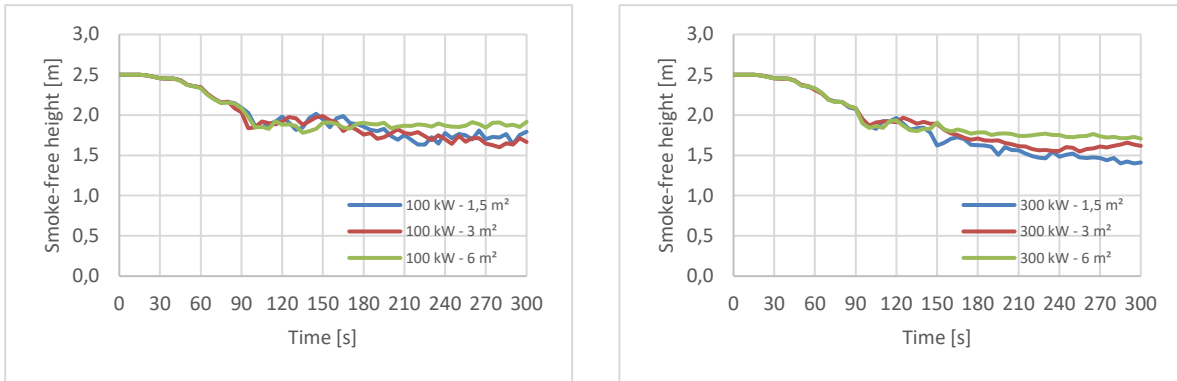

Figure 67: Smoke-free height in case of Heat Release Rate of 100 kW and 300 kW

From the graphs above, it could be concluded that the dimensions of the inlet openings have a minor influence on the smoke-free height. However, as the graphs of visibility (see Figure 66) have shown, this is not the case.

From this it can be concluded that the calculation of the smoke-free height based on the temperature differences over the height, should not be applied in case of a low height and a small Heat Release Rate.

5.4.4 Conclusions

Based on the simulations carried out, the following conclusions can be made:

- In case of a limited height and a small Heat Release Rate, the calculated smoke-free height (in FDS) is not a good parameter to evaluate the actual smoke-free height. After all, this is based on temperature differences in the room.

It is therefore important to always investigate the visibility. Based on the calculated smoke-free height alone, it could be concluded that there is no major influence of the dimensions of the inlet openings on the smoke-free height. However, this is clearly not the case, as demonstrated by the graphs of visibility.

- With a fire capacity of 100 kW, even in the most ideal conditions (six extraction openings), a smoke layer of approx. 0.8 to 1 m is always present. This minimum thickness of the smoke layer is caused by the ceiling jet, as shown below:

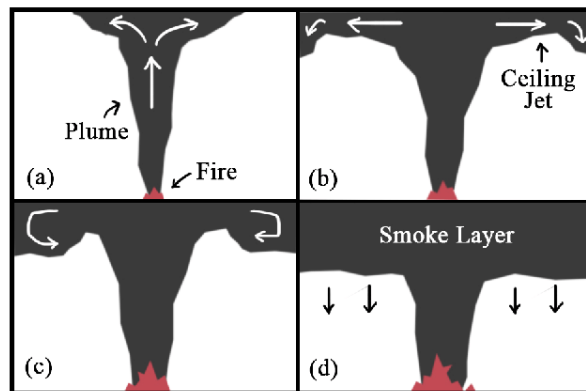

Figure 68: Formation of a stable smoke layer under the influence of the ceiling jet [6]

From the figure above can be deduced that before the smoke layer can become thicker, a stable smoke layer must first form. This stable smoke layer will therefore always have a minimum thickness, even with small Heat Release Rate.

- The velocity at the inlet openings has a very big influence on the formation of a clear separation between the smoke layer and the ambient air. The higher this velocity, the more turbulent the flow in the room and thus the more the smoke layer and the ambient air are blended together.

The separation between smoke layer and ambient air is more pronounced in the simulations with a larger ratio of inlet/exhaust opening.

It is by no means the intention to use the above simulations to determine the smoke-free height.

It is only the intention to demonstrate the influence that inlet flow rates can have on the formation of a clear separation between the smoke layer and the ambient air. On the other hand it also shows that – even with a small Heat Release Rate – each smoke layer has a minimum thickness (and this as a result of the ceiling jet generated by the fire source).

6 CONCLUSIONS

6.1 SMOKE CONTROL

Both during an immediate evacuation and during a delayed evacuation (Defend in Place), it must always be ensured that the evacuating persons are not exposed to the consequences of a fire, in particular exposure to the smoke and other toxic components of the fire source.

In the context of this study and the predetermined safety level in residential care buildings, smoke control is thus defined as *guaranteeing a smoke-free evacuation by means of active and/or passive fire safety measures*.

The principle of smoke control consists in keeping the smoke (and other toxic gases) within the boundaries of the fire room (e.g. by creating an underpressure in the fire room) rather than ensuring that the adjacent compartments to be protected "block" the smoke (e.g. by creating an overpressure in these adjacent compartments). After all, once the smoke is outside the boundaries of the fire room, its propagation to the rest of the building is unpredictable given the pressure differences that may be present in the building at that time due to, for example, the presence of ventilation systems, the weather influences, the height of the building, etc., as well as the possible interaction with the fire brigade during their intervention.

Moreover, the domain of application as well as the design parameters of the smoke control system are not always the same, as they depend on the chosen evacuation strategy.

Given the innovative nature of the smoke control system, i.e. there are no design parameters available for the different applications of the system, this study attempted to establish these design parameters in a pragmatic way. The conclusions of the large-scale fire tests, as well as those of the additional CFD simulations, served as a basis for this.

To make it clear that this application of a smoke control system is different from the known applications of smoke control systems (i.e. atria, industrial buildings and parking garages), the smoke control system used in this study is also called "residential smoke control system".

6.2 INFLUENCE OF THE AIRTIGHTNESS OF THE FIRE ROOM ON THE SPREAD OF SMOKE

The more airtight the room (= small leak surfaces), the higher the overpressure in this room can increase in the event of a fire, thus the more smoke propagation to adjacent compartments is possible. The duration of this smoke propagation is determined by the dimensions of the fire room (= amount of available oxygen to maintain the fire source), while the amount of smoke propagation (= volume flow rate of the smoke) is determined by the overpressure's extent in the fire room. A large volume (e.g. common area) can result in high pressure differences that, given the amount of oxygen in the room, can increase for a relatively long time, while a small volume (e.g. occupant room) can also result in high pressure differences but where these don't last as long.

In an airtight room, the pressure difference is less dependent on the height, i.e. an overpressure is present over the entire height. In this case, any opening (= connection to an adjacent compartment) in the room will be subject to an overpressure and will result in smoke propagation to the adjacent compartment.

By making the fire room less airtight (= creating additional openings), it is therefore possible that there is an overpressure at the top of the room, while there is an underpressure at the bottom of the room. In such a case, the position of the openings (= connection to an adjacent compartment) is important. The spread of smoke is thus not only dependent on the overpressure in the fire room, but also on the location of the openings in relation to this overpressure. If the openings are located in the area of the underpressure, an overpressure in the fire room is therefore perfectly possible without having the spread of smoke to the adjacent compartments.

Subsequently, the surface area of the openings (= connections) between the fire room and an adjacent compartment determines the amount of smoke that passes through this opening. For example, during the large-scale fire tests, it has been shown that a smoke control door is much more efficient in preventing the spread of smoke than a fire resistant door given the very small leakage surface of the smoke control door.

Finally, it must also be taken into account that the smoke present in an airtight fire room can be "pushed" to adjacent rooms under the influence of a pressure wave, i.e. a very sudden increase in pressure. This can be, for example, by closing doors, i.e. the spread of smoke as a result of a pressure build-up is not only caused by the fire source itself.

6.3 EVACUATION THROUGH A FIRE ROOM

The large-scale fire tests have shown that an evacuation through a fire room is only possible when a residential smoke control system and a fire screen are used.

This application of the smoke control system can thus be used when an immediate evacuation is part of the evacuation strategy.

If the common area (= fire room) is connected to other compartments (e.g. through the ventilation system, doors, etc.), the smoke control system can also provide an underpressure in the fire room (see § 6.4) so that this application can also be used in the event of a Defend in Place.

In the event of a fire, the fire screen will go down and can either stop at a predetermined height above the ground (e.g. if obstacles could be present in the room) or go down completely. This way, a separation is created between the fire room and the evacuating person. As soon as the fire screen is in the chosen position, the smoke control system is activated and will ensure that the smoke remains within the boundaries of the fire room (but outside the created evacuation route). This (new) smoke-free evacuation route must comply with the general requirements applicable to evacuation routes.

The design parameters for the residential smoke control system where the fire screen stops at a maximum height of 1 m above the ground are given in § 5.3.5. In this application of the smoke control system, a minimum velocity under the opening of the fire screen is imperative to keep the created evacuation route smoke-free. In addition, it is important that the distance from the inlet openings to the opening under the fire screen is large enough and/or that the velocity through the inlet openings is limited, in order not to have a backflow (of smoke) from the fire room to the created evacuation route.

The design parameters for the residential smoke control system where the fire screen goes completely down are given in § 5.2.6. In this application of the smoke control system, a measure must be taken to prevent a possible smoke propagation to the created evacuation route (originating from the starting fire and present in the evacuation route before the activation of the fire screen) (see also § 4.3.7).

With the exception of the design parameters shown above, the residential smoke control system is constructed according to the applicable standards for SHEV systems described in § 2.6.1, whereby the openings of a ventilation system may be passively used as inlet openings of the smoke control system.

However, given the highly innovative nature of this smoke control system, it is advisable to draw up a document that allows a practical design and inspection of the system.

6.4 PREVENTING THE SPREAD OF SMOKE (AND THE SPREAD OF OTHER TOXIC GASES) TO ADJACENT COMPARTMENTS

The large-scale fire tests have shown that the spread of smoke (and the spread of other toxic gases) to adjacent compartments can be prevented when a residential smoke control system is used.

This application of the smoke control system can thus be used when a Defend in Place is part of the evacuation strategy.

To prevent such spread of smoke, an underpressure is realized in the fire room and the resident can wait for the (postponed) evacuation in a smoke-free (adjacent) environment. The smoke control system will ensure that the smoke remains within the boundaries of the fire room.

In the event of a fire, the smoke control system is activated with a predetermined (low) extraction flow rate. In this application, a pressure control system can be used in which the extraction flow rate of the smoke control system then adapts to the measured pressure difference in the fire room.

The design parameters for this application of the residential smoke control system are given in § 5.2.6.

Based on the additional CFD simulations, it has been established that the pressure difference in the fire room is not only influenced by the openings (in the fire room) and the extraction flow rate, but also by the air temperature in the exhaust openings.

The first two parameters (i.e. openings and extraction flow rate) mainly have an influence on the maximum underpressure to be achieved in that fire room (= initial pressure difference), while the air temperature in the exhaust opening has a major influence on the pressure difference (= a minimum underpressure or possibly even an overpressure) in the fire room.

Finally, it is important to have a minimal opening in the fire room in order to neutralize the pressure build-up as a result of the fire source.

With the exception of the design parameters shown above, the residential smoke control system is constructed according to the applicable standards for SHEV systems described in § 2.6.1, whereby the openings of a ventilation system may be passively used as inlet openings of the smoke control system.

However, given the highly innovative nature of this smoke control system, it is advisable to draw up a document that allows a practical design and inspection of the system.

6.5 MAKING THE FIRE ROOM SMOKE-FREE

Only if the velocities at the inlet openings of a smoke control system are small, it is possible to achieve a clear separation between a uniform smoke layer and the ambient air underneath (= minimum smoke-free height) in the event of a smoldering fire or a fire with a small Heat Release Rate. It should be taken into account that the smoke layer will always have a minimum thickness of approx. 1 m.

In a situation where the velocities at the inlet openings are too high, no clear smoke layer can be created. A smoke control system in this case cannot provide a smoke-free evacuation route.

If the fire is completely extinguished, it can be obtained that a room can be quickly made smoke-free by imposing a certain renewal rate.

If the fire is not completely extinguished and therefore a (small) smoke production still takes place, a residential smoke control system can ensure that on the one hand the fire room (= evacuation route) is placed in underpressure (see also § 2.4) so that the action of the fire brigade during their intervention – in case of a (very) airtight fire room – will not cause any further spread of smoke (see § 2.5.3) but also, on the other hand, that the visibility in the fire room is improved so that the fire brigade can extinguish the fire completely.

If a Defend in Place is part of the evacuation strategy, the intervention of the fire brigade is essential in obtaining a successful evacuation. The above-mentioned application of the residential smoke control system can be an important tool for the fire brigade during their intervention if the evacuation route has to be made smoke-free.

7 SOURCES

- [1] „https://www.departementwvg.be/sites/default/files/media/documenten/VIPA_Brandveiligheid_in_ouderenvoorzieningen.pdf,” [Online].
- [2] „VIPA/2014/BVO - Brandveiligheid in ouderenvoorzieningen: Onderzoek naar de doelmatigheid van alternatieve brandveiligheidsmaatregelen in nieuwe zorgconcepten,” 2014.
- [3] Steunpunt Welzijn, Volksgezondheid en Gezin, *Analyse van experimenten en numerieke simulaties van brandproeven voor de ontwikkeling van een beoordelingskader voor brandveiligheid in zorggebouwen*, 2021.
- [4] Instituut Fysieke Veiligheid (IFV), *Rookverspreiding in woongebouwen. Hoofdrapport van de praktijkexperimenten in een woongebouw met inpandige gangen*, 16 september 2020.
- [5] Björn Karlsson & James G. Quintière, *Enclosure Fire Dynamics*, 2000.
- [6] O. Hasaniah & L. Viney, *Smoke Models For Buildings*, 2018.

8 ANNEXES (MEASUREMENTS DURING THE LARGE-SCALE FIRE TESTS)

8.1 TEST 1: "REFERENCE TEST"

The results of the measurements (temperature, CO and pressure) are shown below:

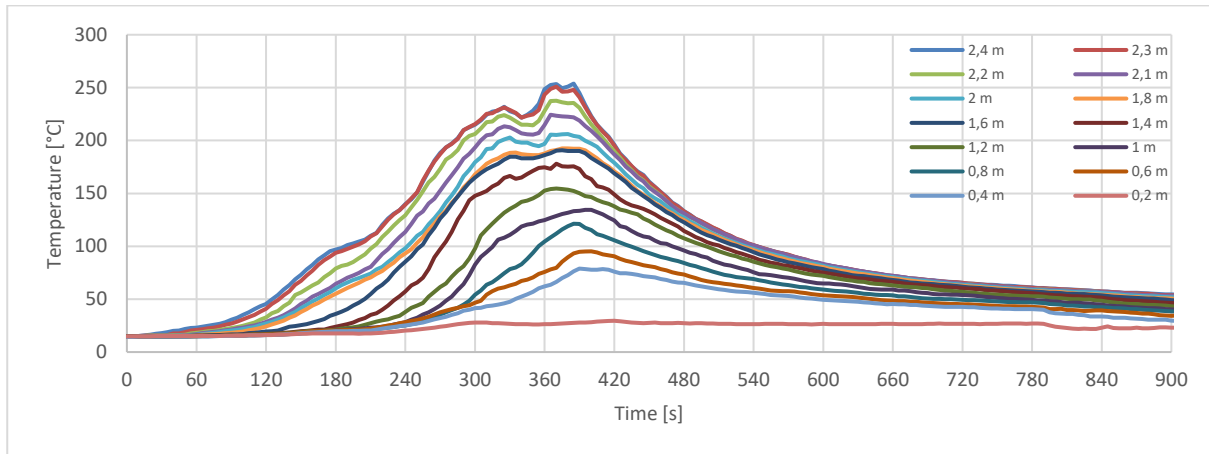

Temperatures measured in the common area (further away from the fire source)

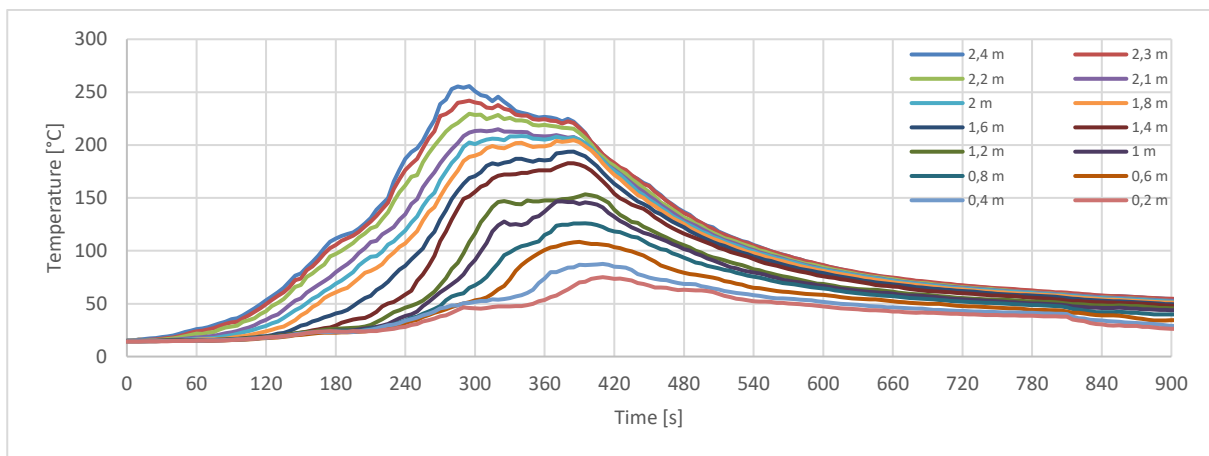

Temperatures measured in the common area (closer to the fire source)

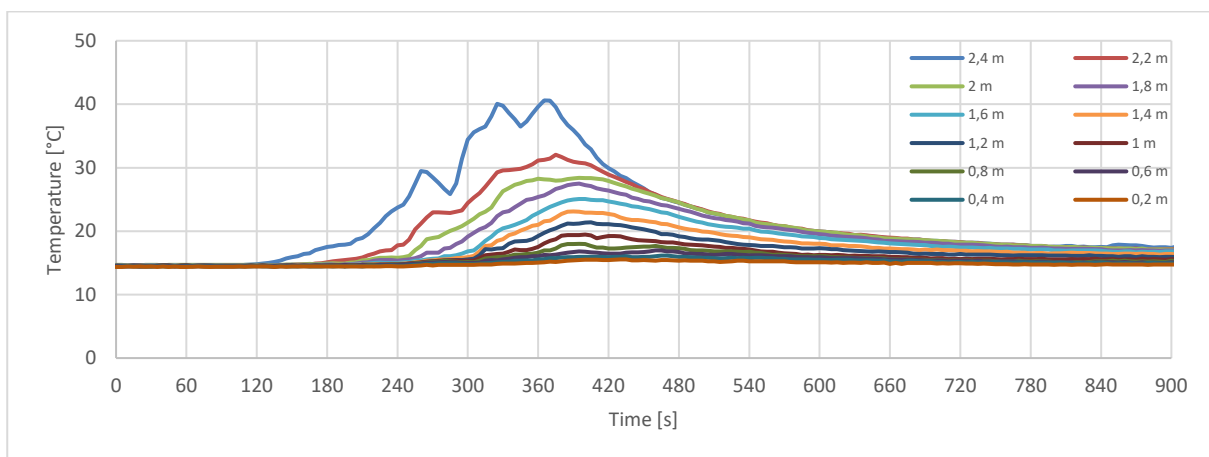

Temperatures measured in the room provided with a fire resistant door

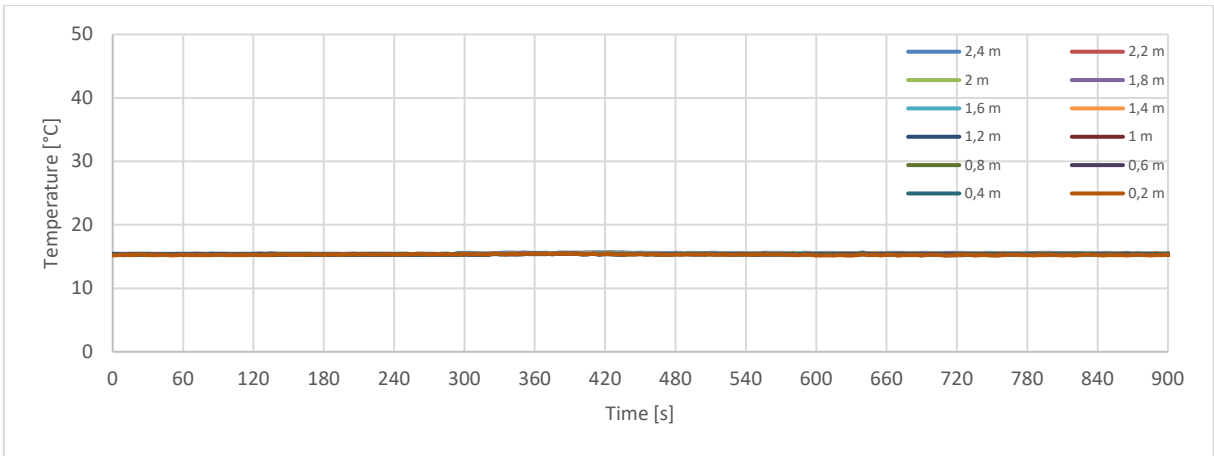

Temperatures measured in the room provided with a smoke control door

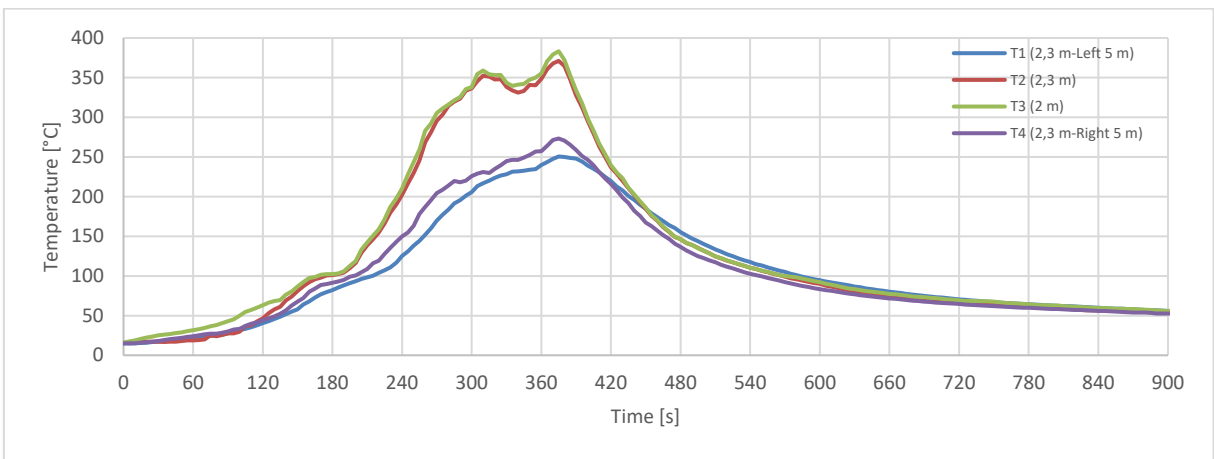

Temperatures measured on the wall directly opposite the fire source

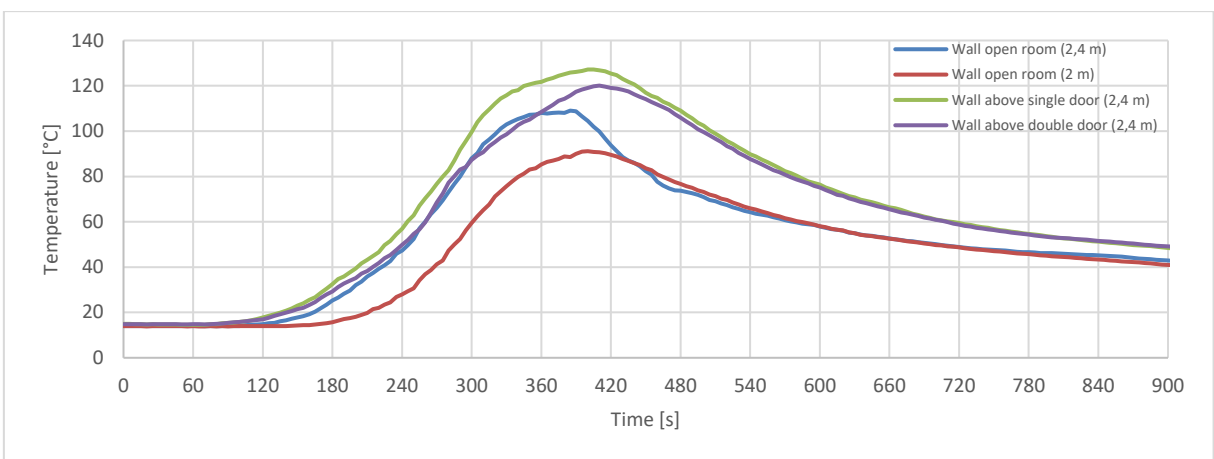

Temperatures measured at different locations in the fire room

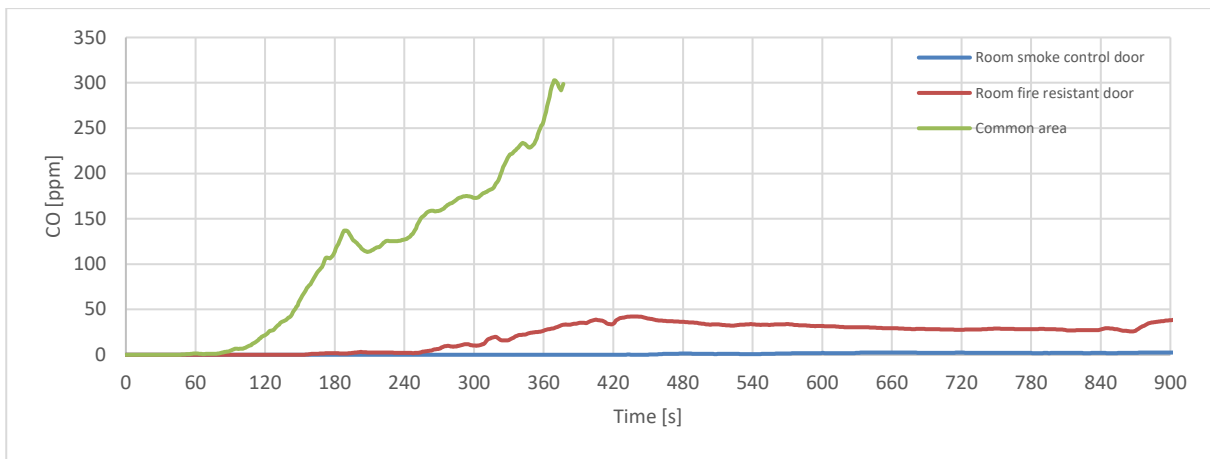

CO content in the rooms and the common area (upper limit measurement: 500 ppm)

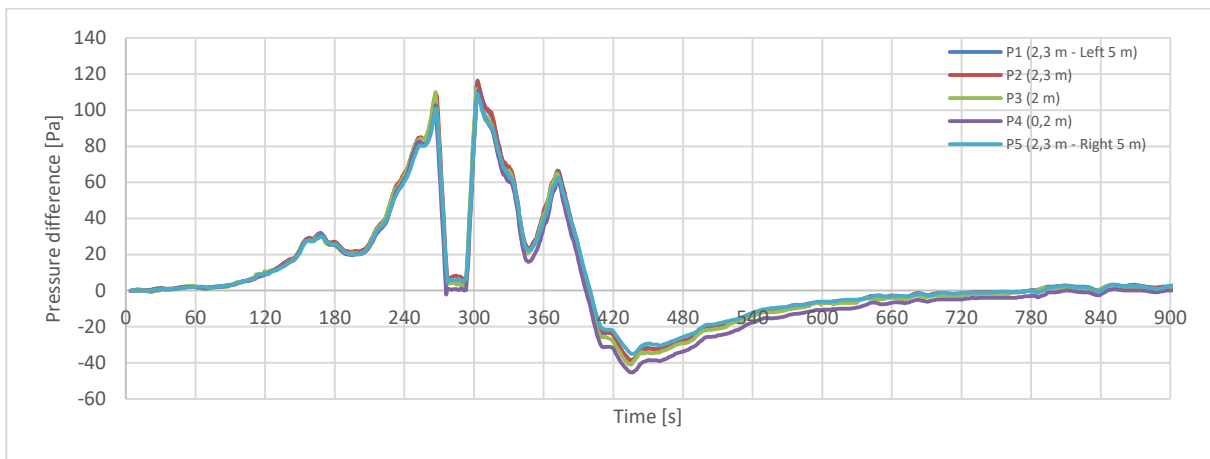

Pressure difference in the common area

8.2 TEST 2: APPLICATION OF A FIRE SCREEN (UP TO 0.9 M ABOVE THE GROUND)

The results of the measurements (temperature, CO and pressure) are shown below:

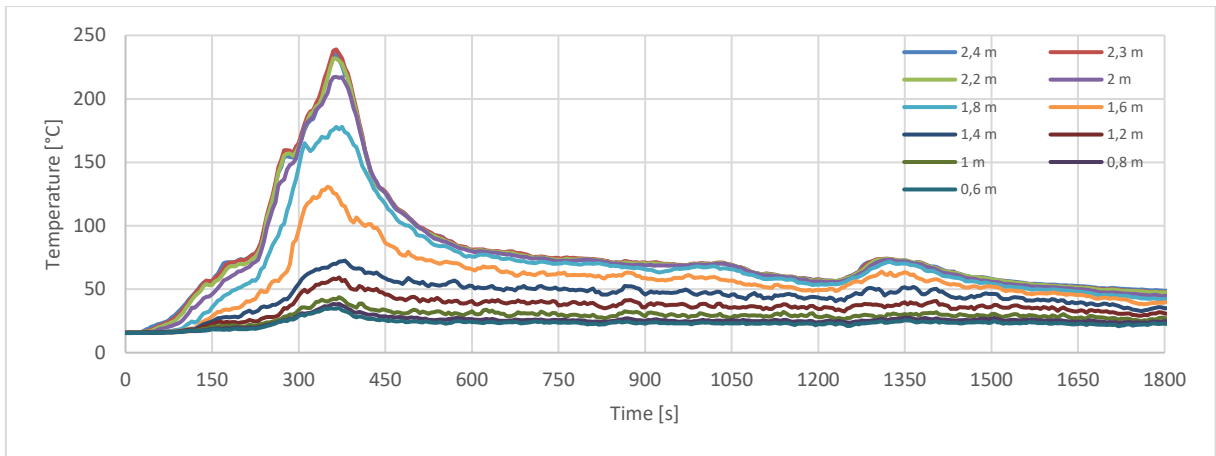

Temperatures measured in the common area (further away from the exhaust openings)

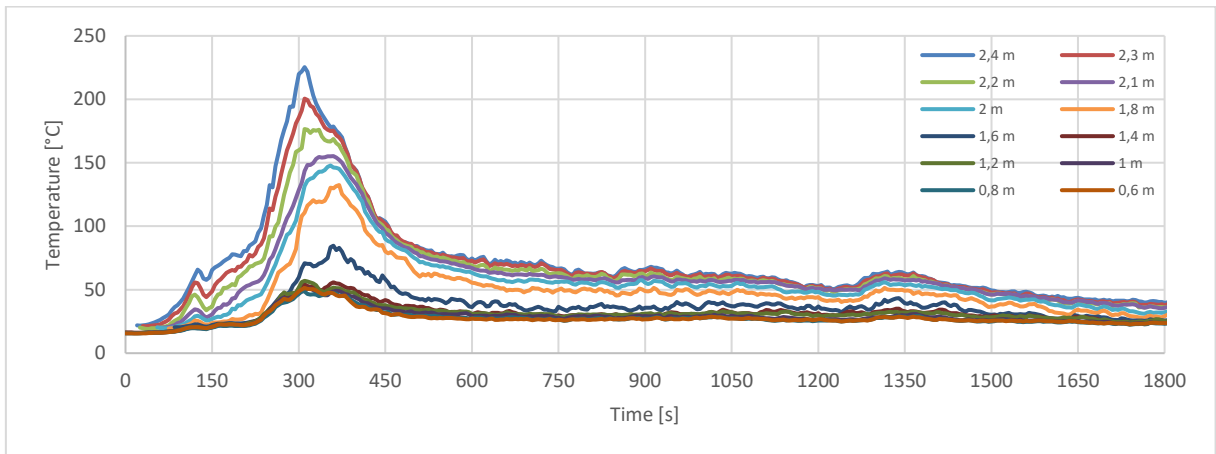

Temperatures measured in the common area (closer to the exhaust openings)

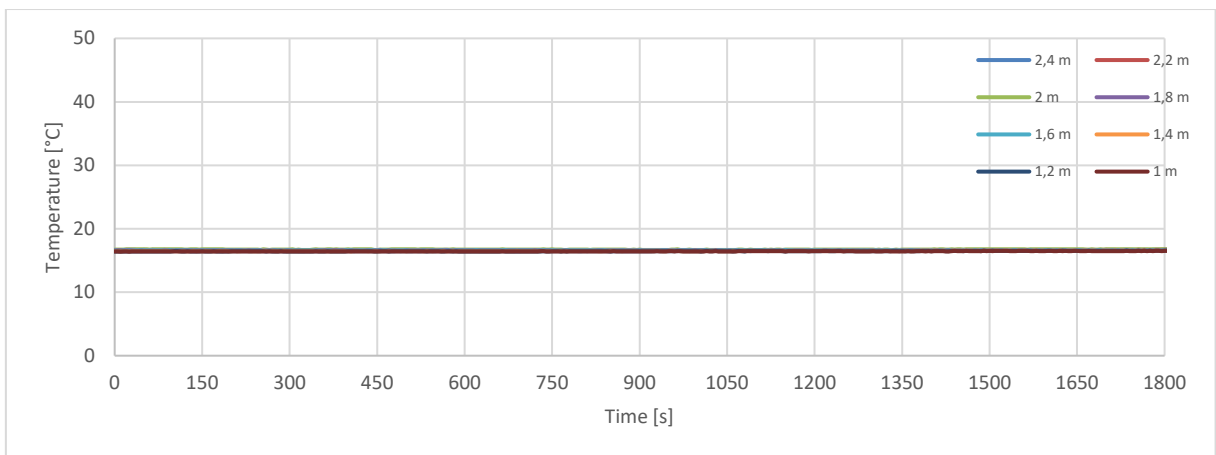

Temperatures measured in the room provided with a fire resistant door

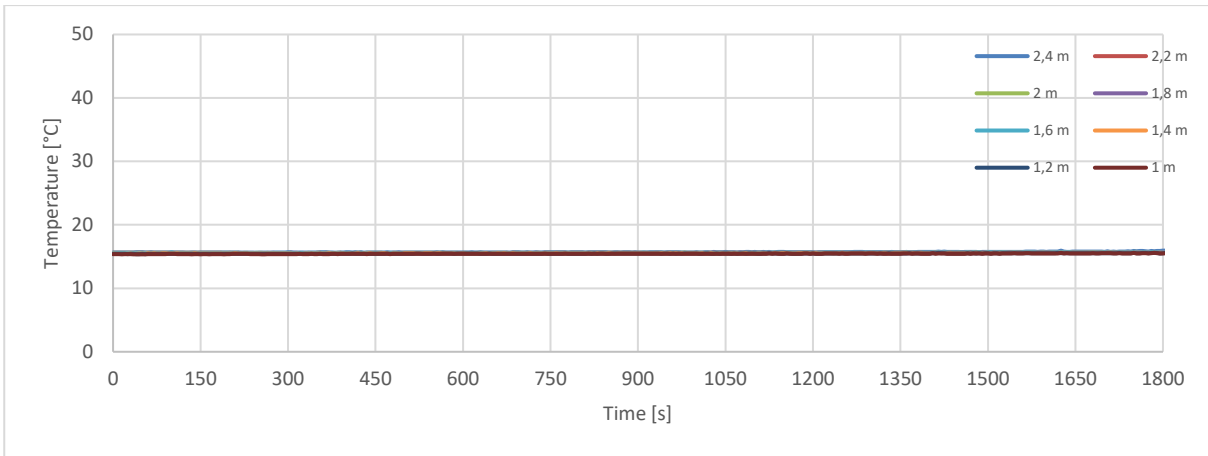

Temperatures measured in the room provided with a smoke control door

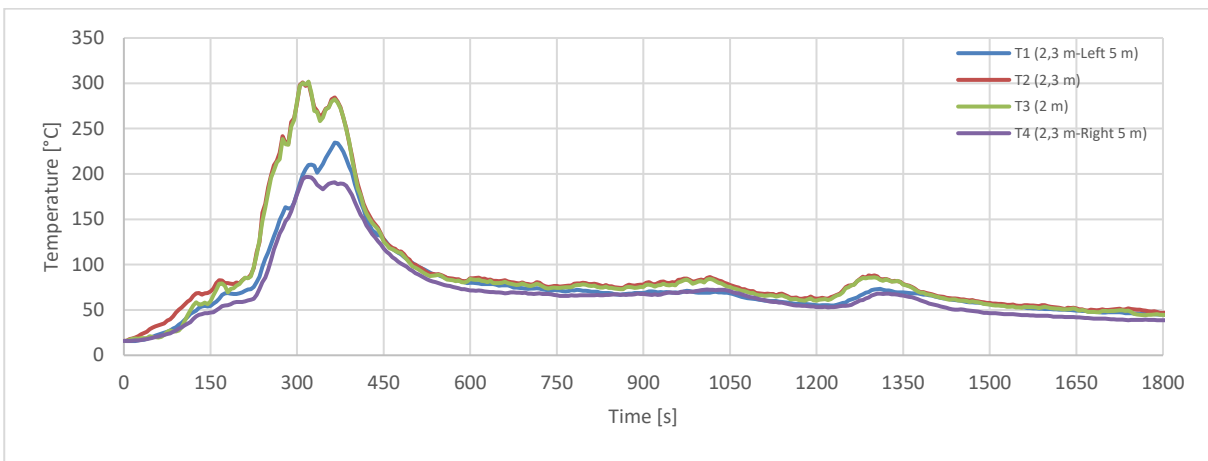

Temperatures measured on the wall directly opposite the fire source

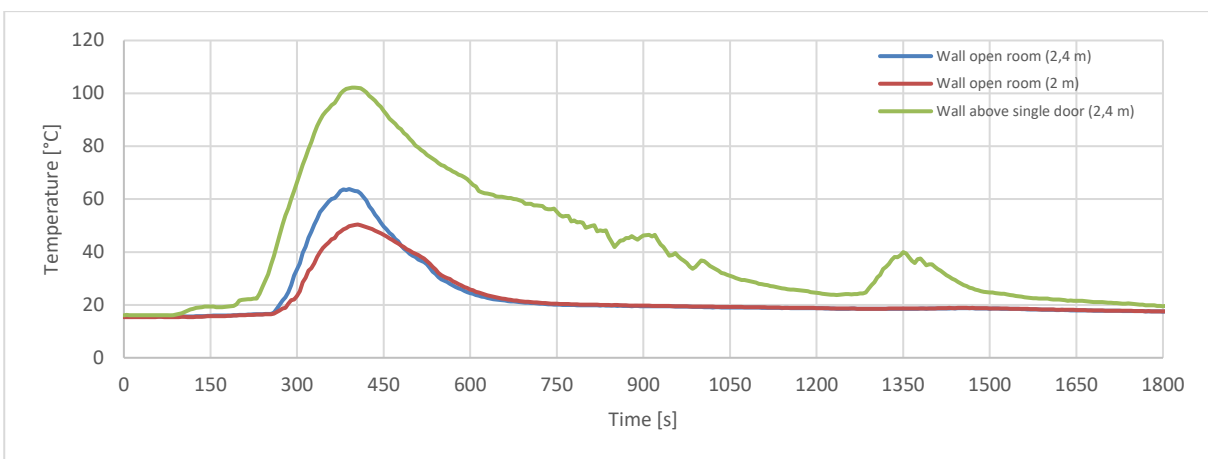

Temperatures measured at different locations in the fire room

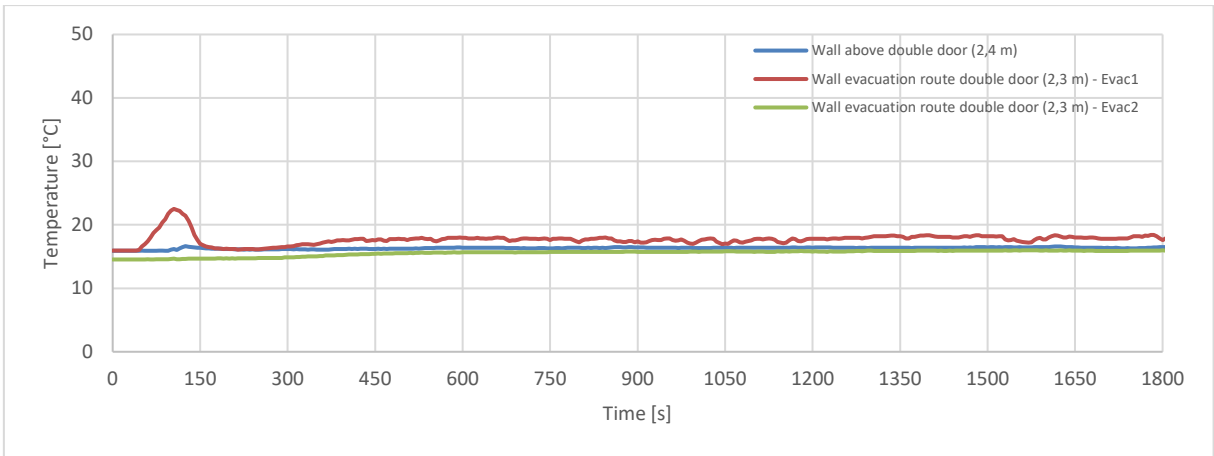

Temperatures measured at different locations in the fire room

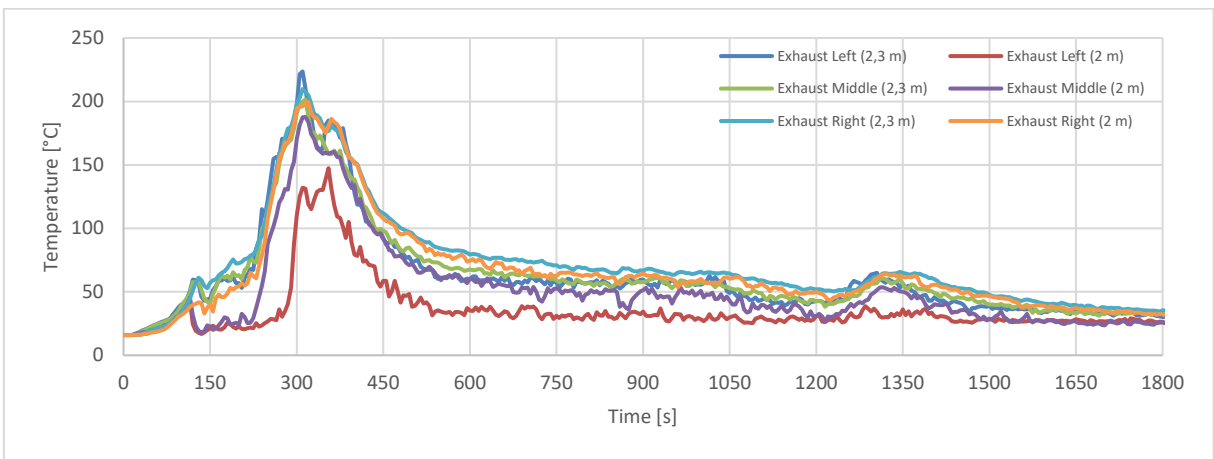

Temperatures measured in the exhaust vents of the smoke control system

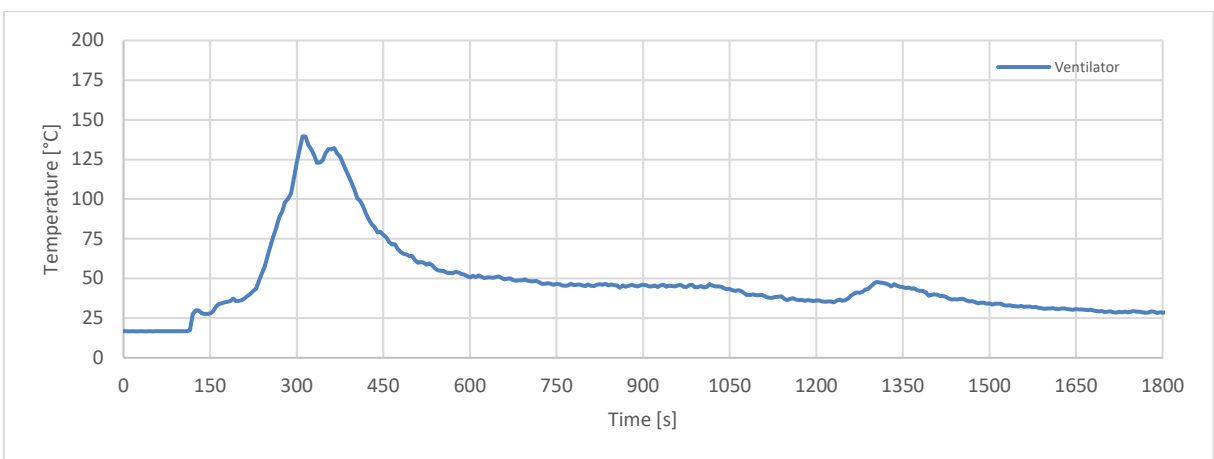

Temperatures measured in the duct of the smoke control system

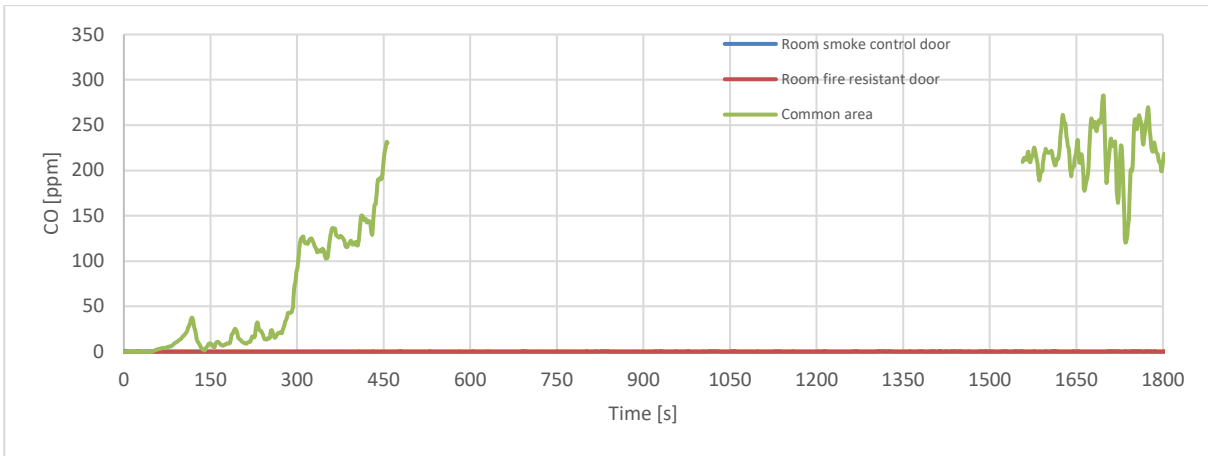

CO content in the rooms and the common area (upper limit measurement: 500 ppm)

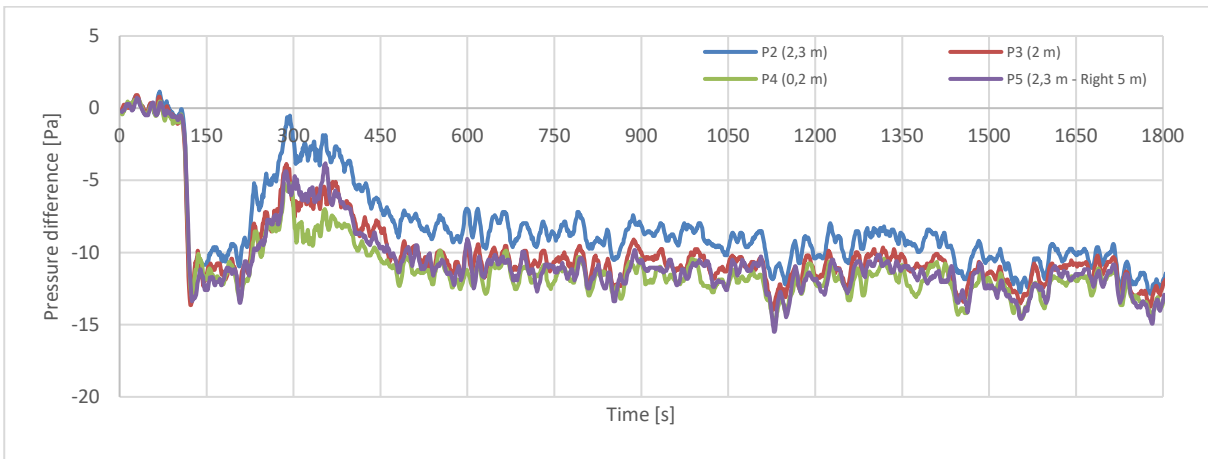

Pressure difference in the common area

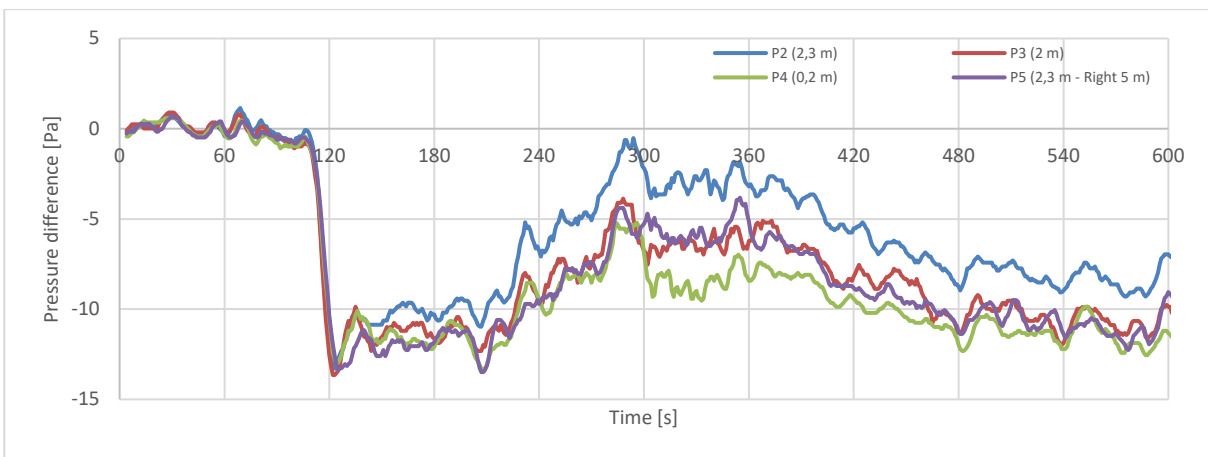

Pressure difference in the common area (first 10 minutes)

8.3 TEST 3: APPLICATION OF A FIRE SCREEN (COMPLETELY DOWN)

The results of the measurements (temperature, CO and pressure) are shown below:

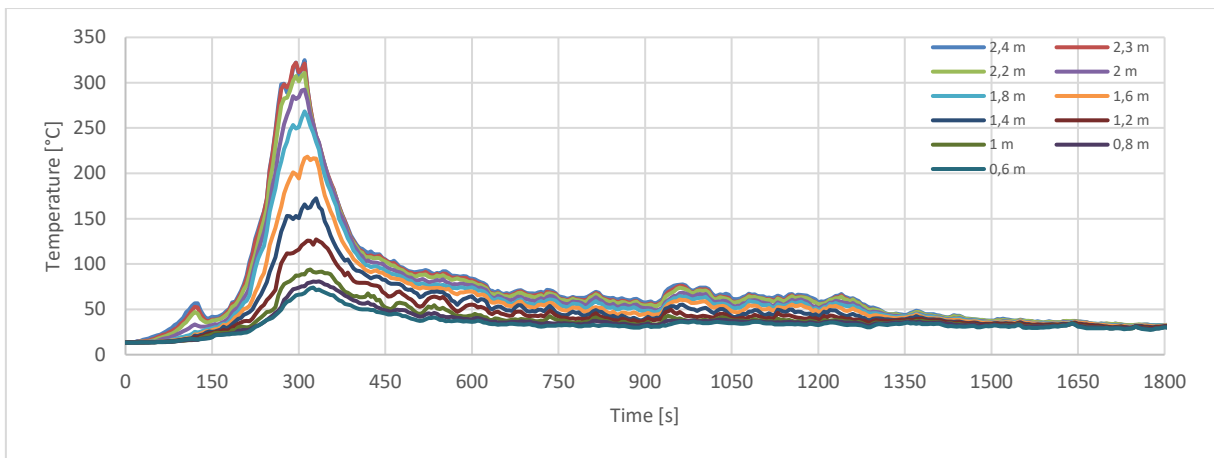

Temperatures measured in the common area (further away from the exhaust openings)

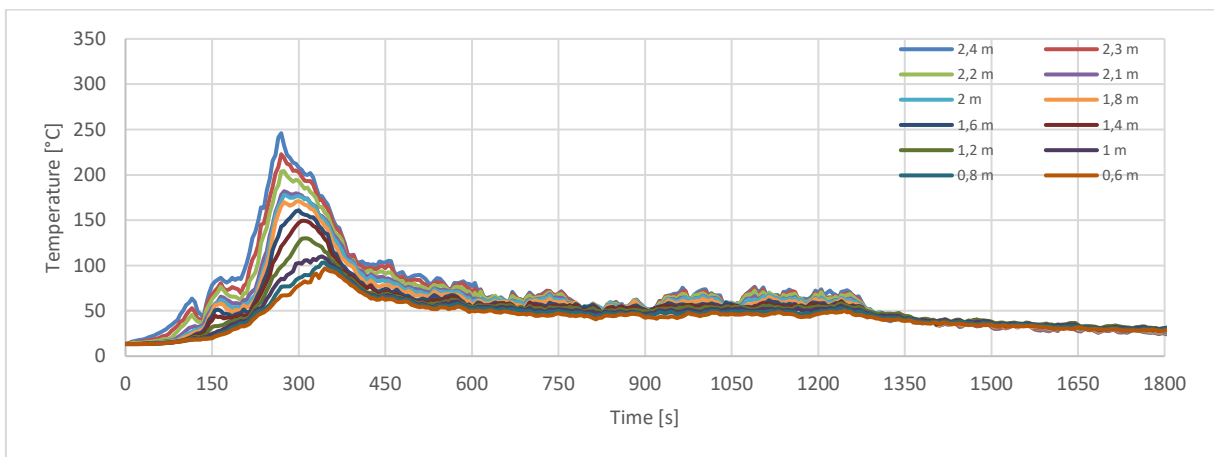

Temperatures measured in the common area (closer to the exhaust openings)

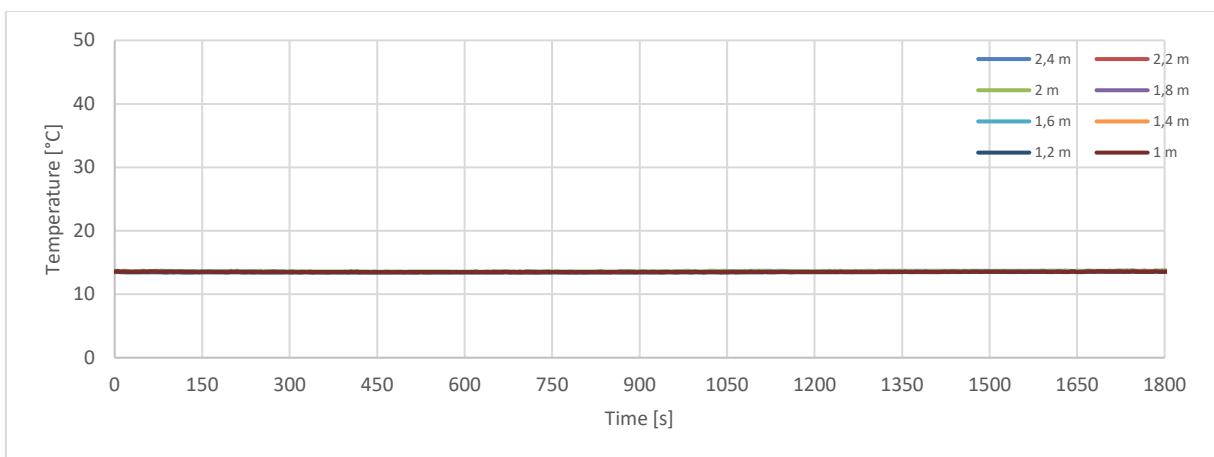

Temperatures measured in the room provided with a fire resistant door

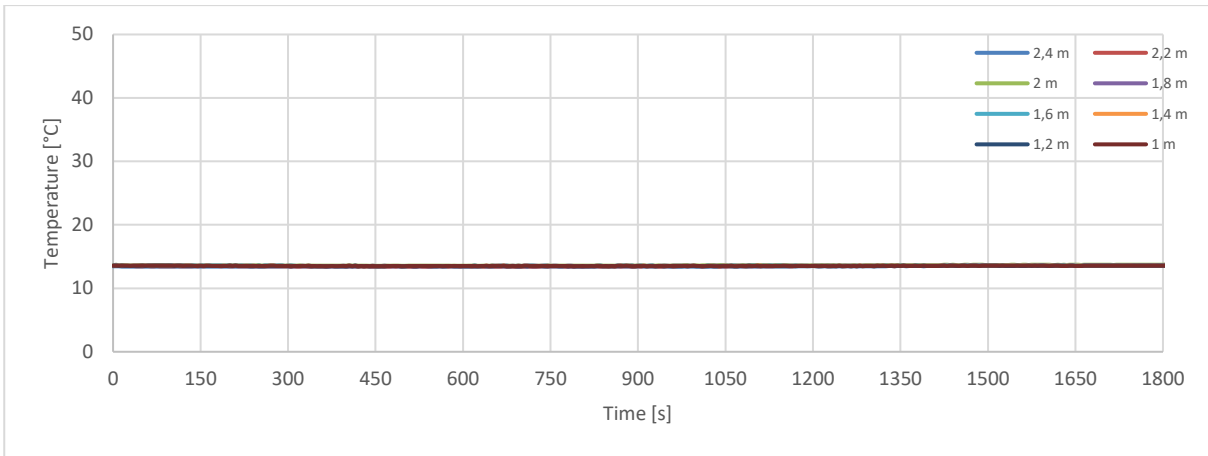

Temperatures measured in the room provided with a smoke control door

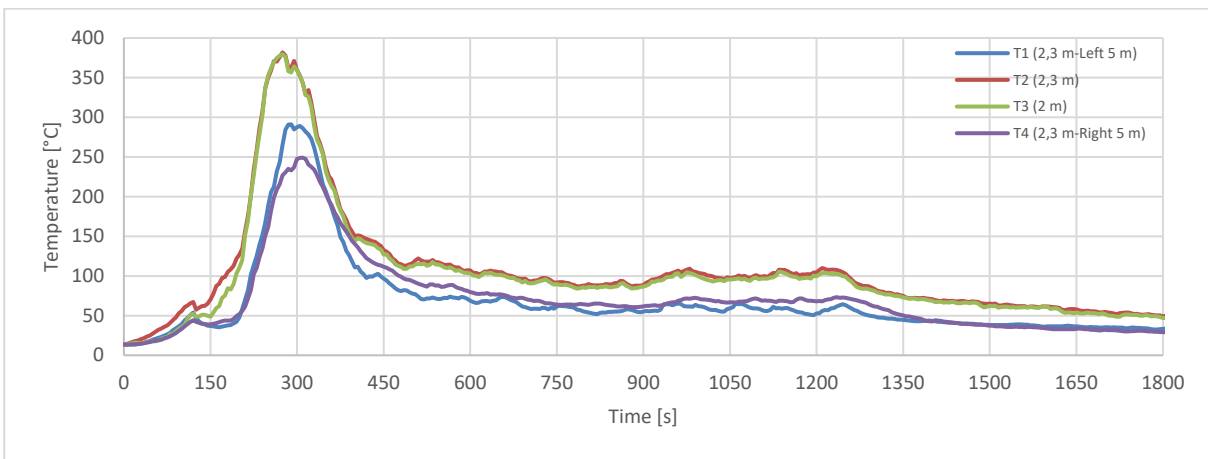

Temperatures measured on the wall directly opposite the fire source

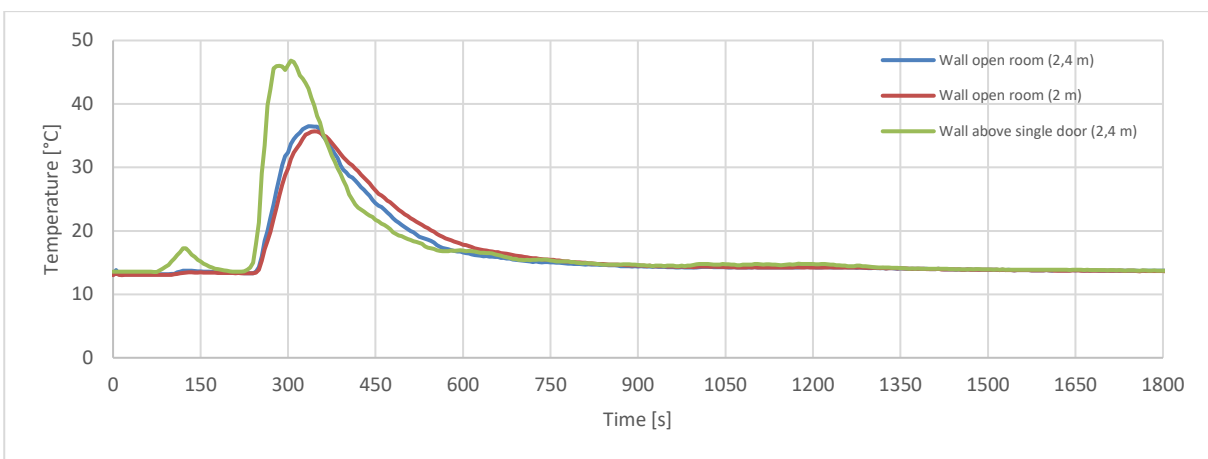

Temperatures measured at different locations in the fire room

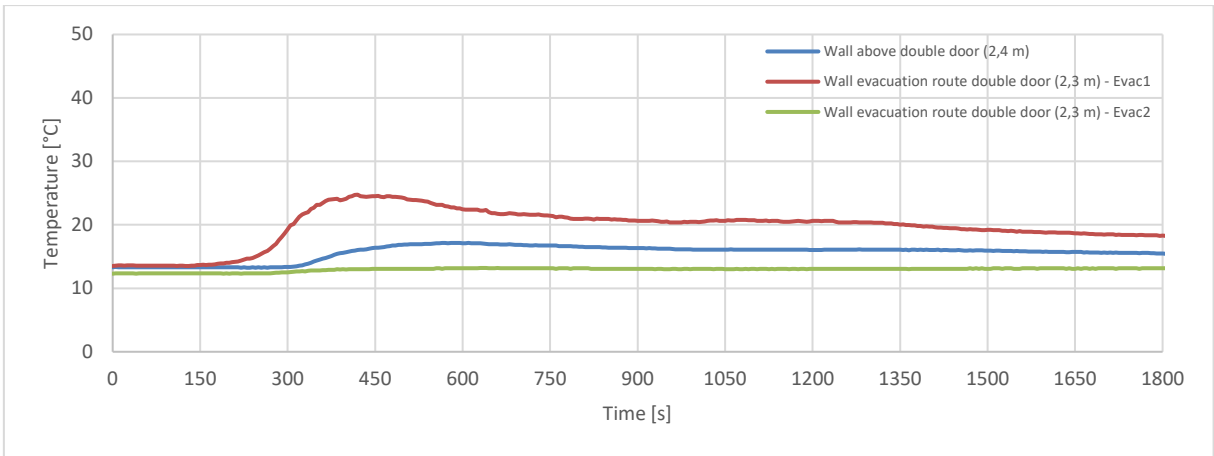

Temperatures measured in the smoke-free evacuation route

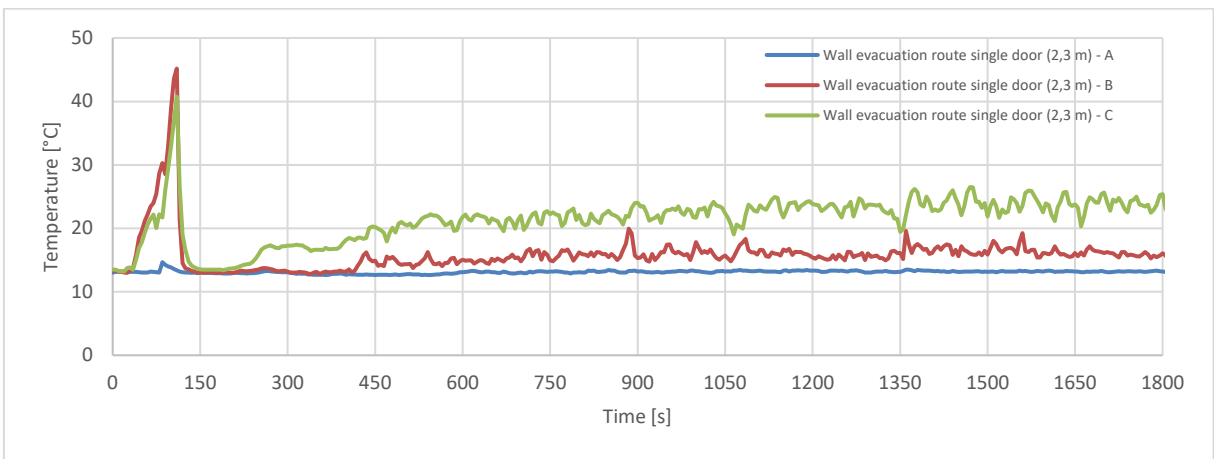

Temperatures measured in the inlet openings

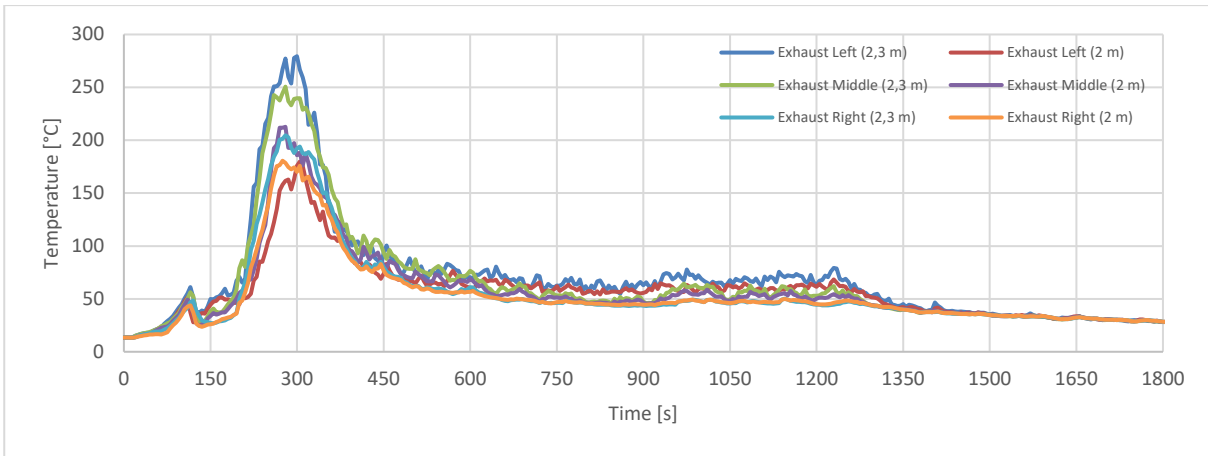

Temperatures measured in the exhaust vents of the smoke control system

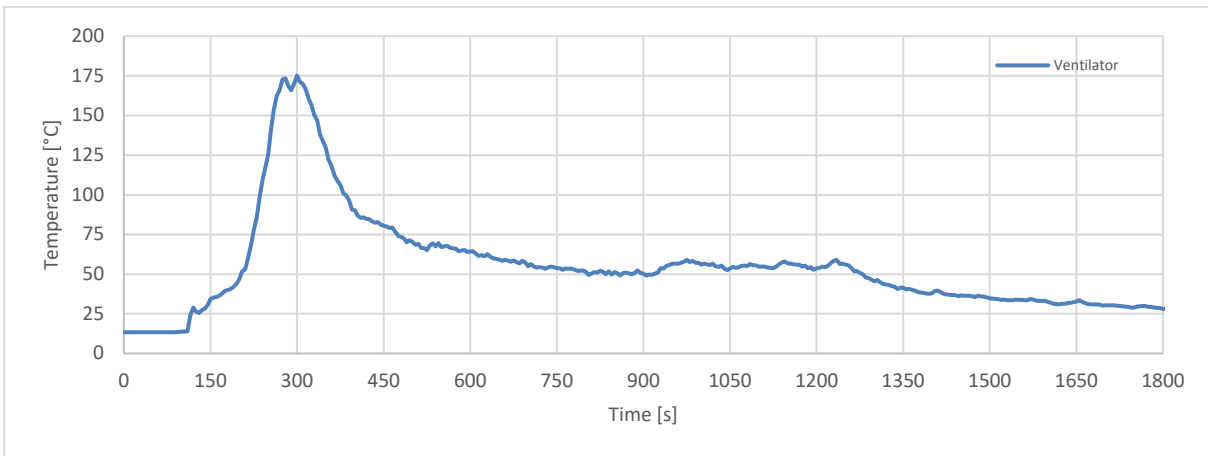

Temperatures measured in the duct of the smoke control system

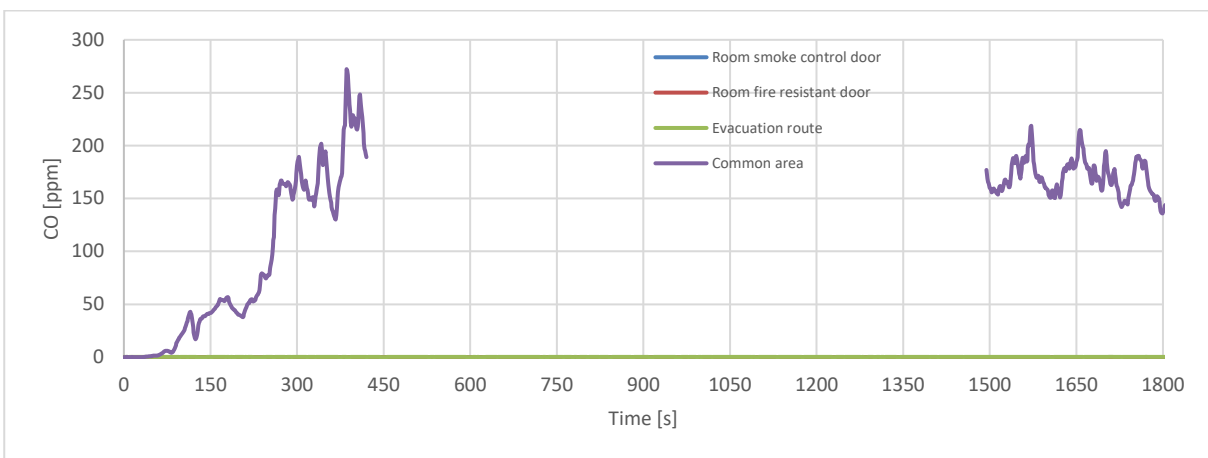

CO content in the rooms and the common area (upper limit measurement: 500 ppm)

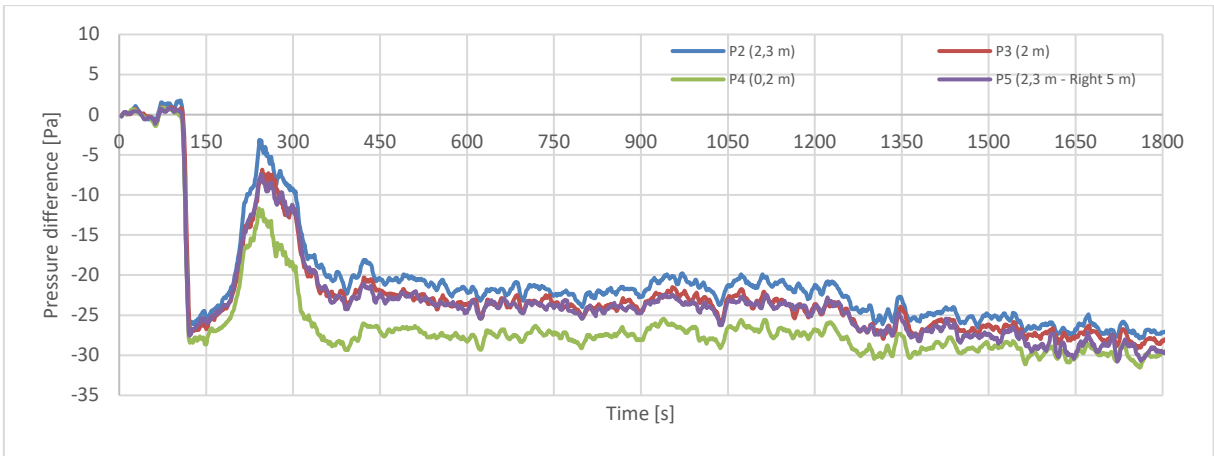

Pressure difference in the common area

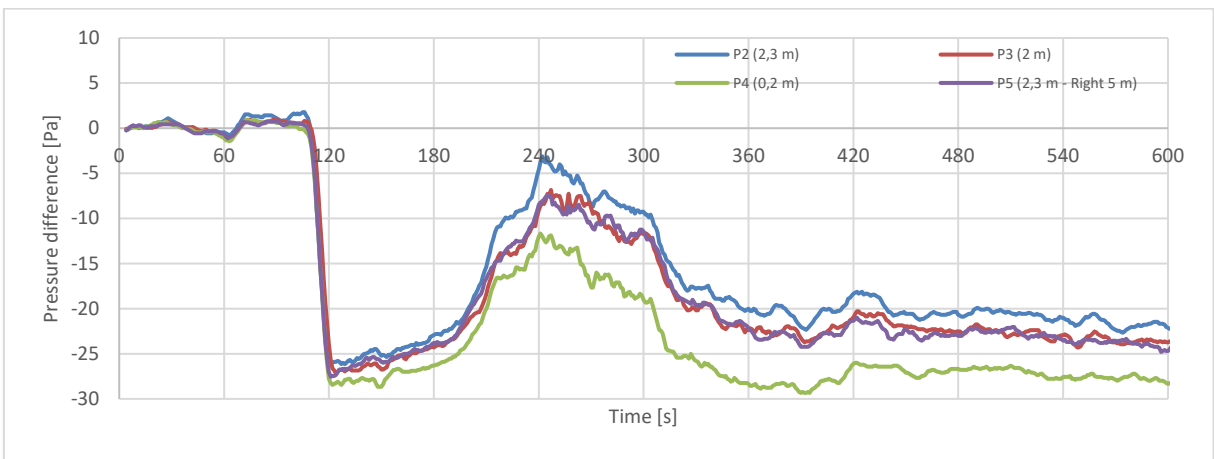

Pressure difference in the common area (first 10 minutes)

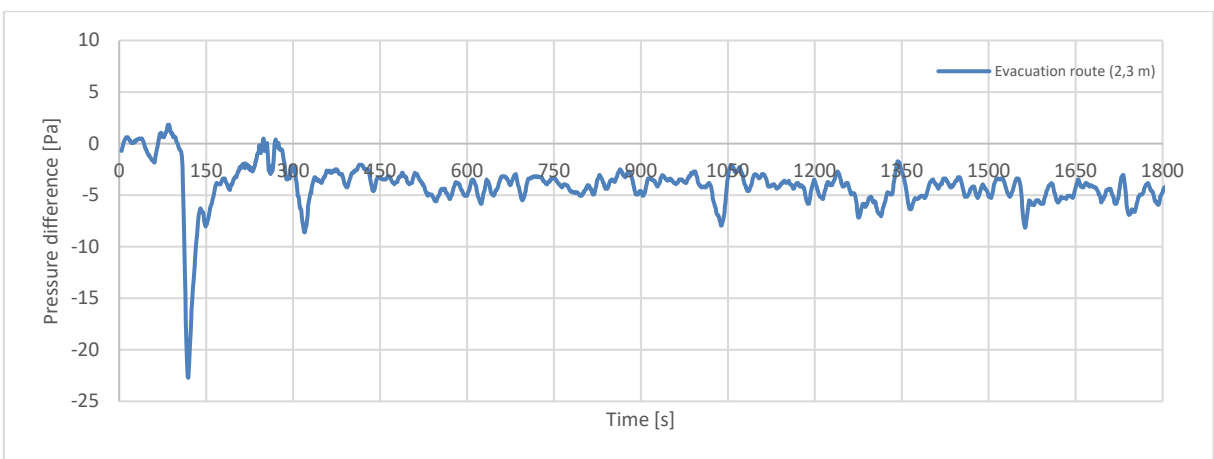

Pressure difference in the evacuation route

8.4 TEST 4: APPLICATION OF AN ADJUSTABLE SMOKE CONTROL SYSTEM

The results of the measurements (temperature, CO and pressure) are shown below:

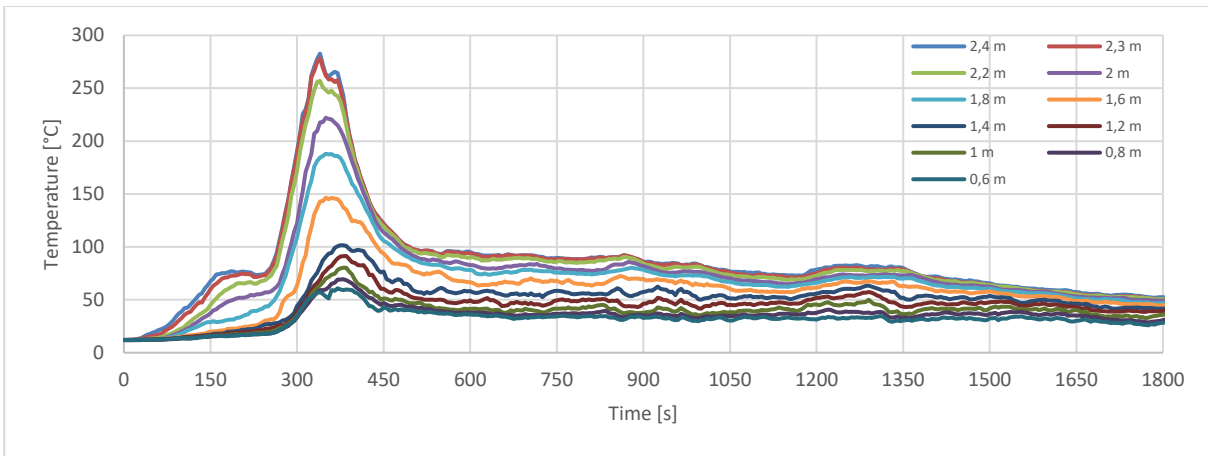

Temperatures measured in the common area (further away from the exhaust openings)

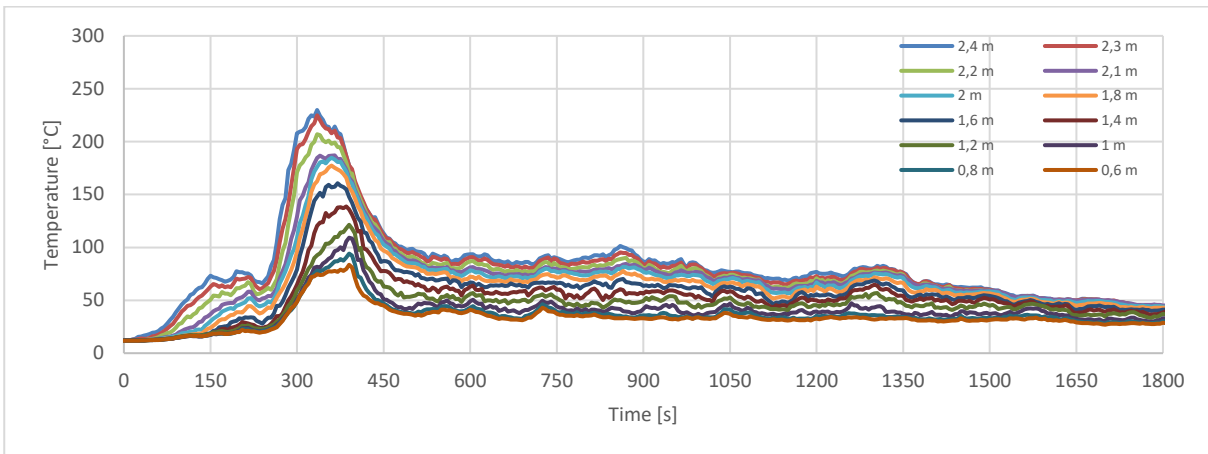

Temperatures measured in the common area (closer to the exhaust openings)

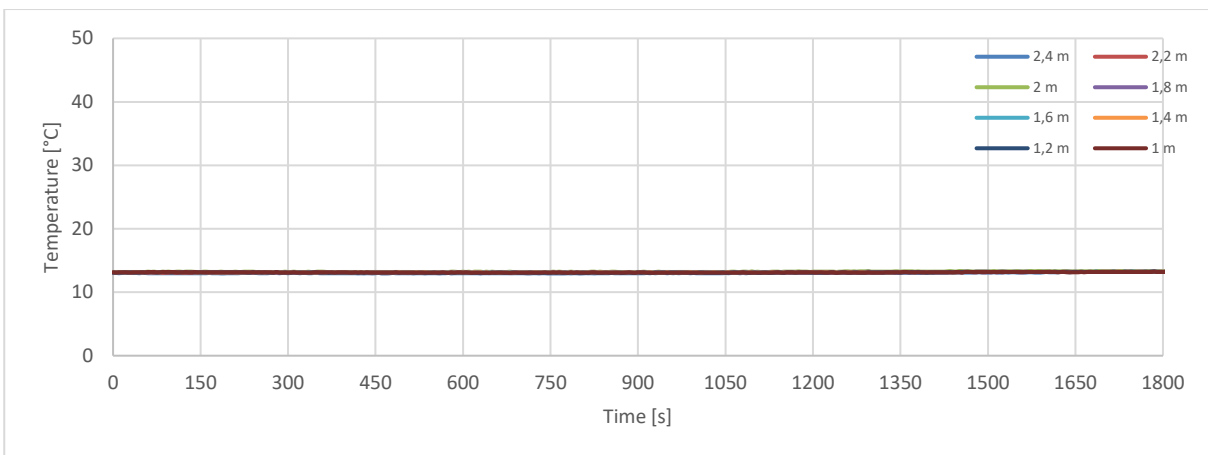

Temperatures measured in the room provided with a fire resistant door

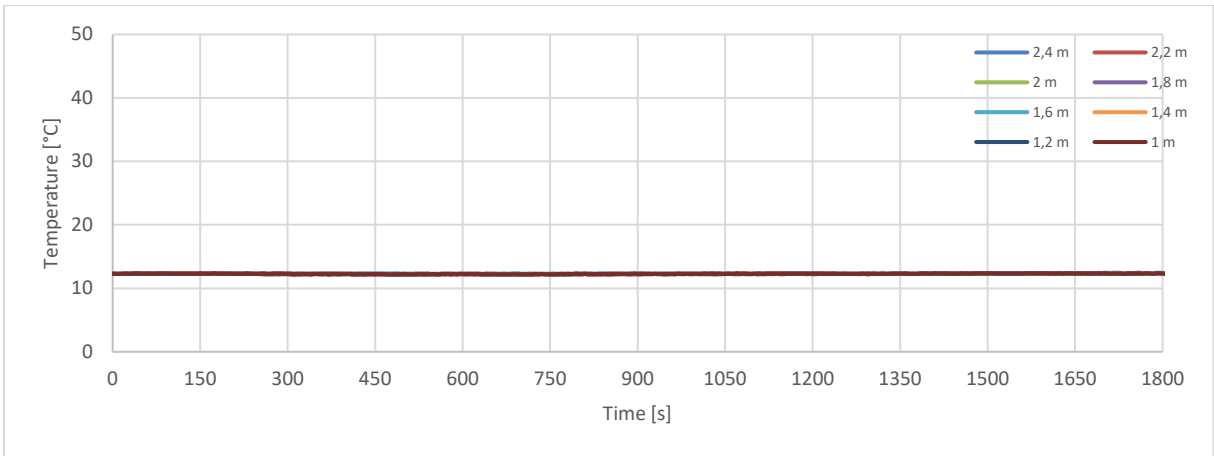

Temperatures measured in the room provided with a smoke control door

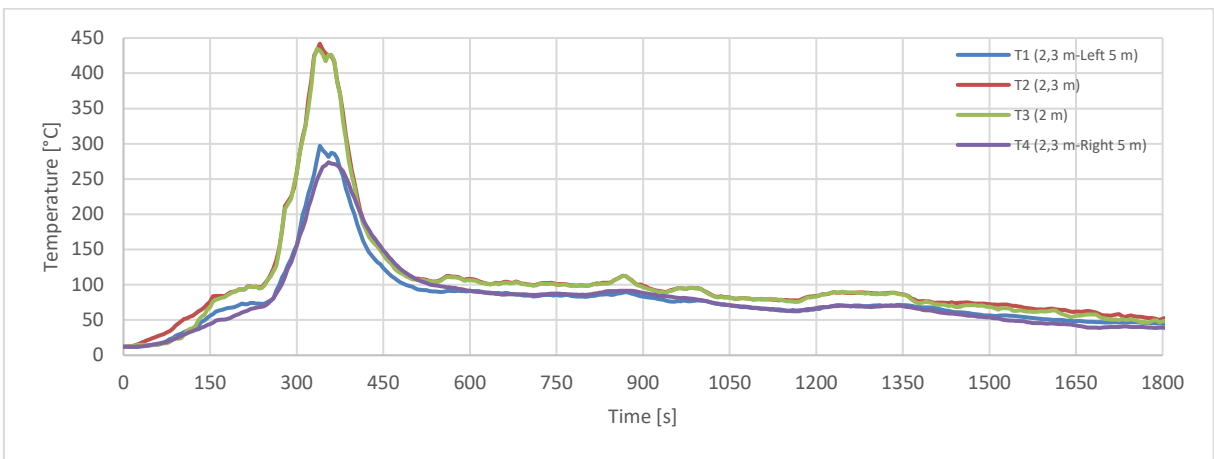

Temperatures measured on the wall directly opposite the fire source

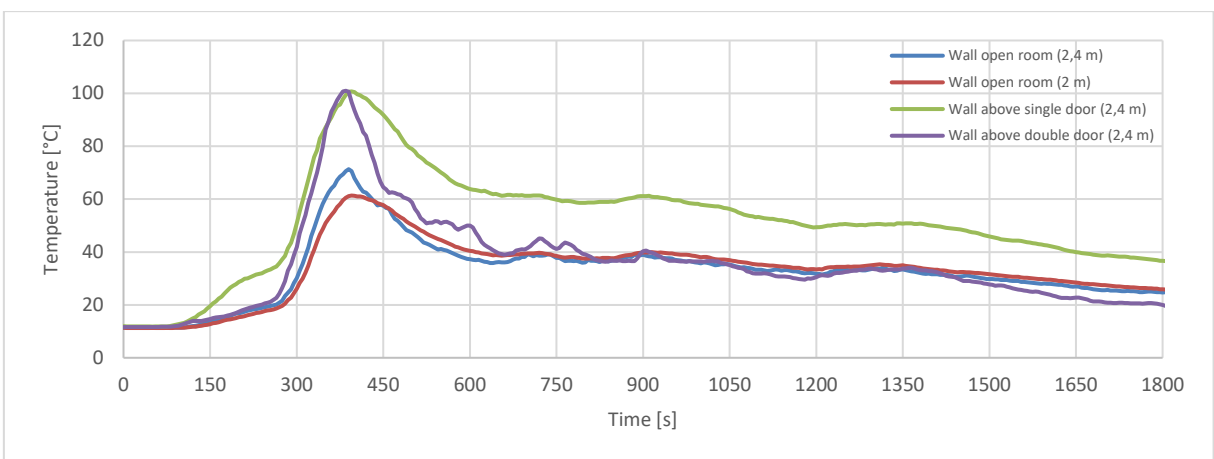

Temperatures measured at different locations in the fire room

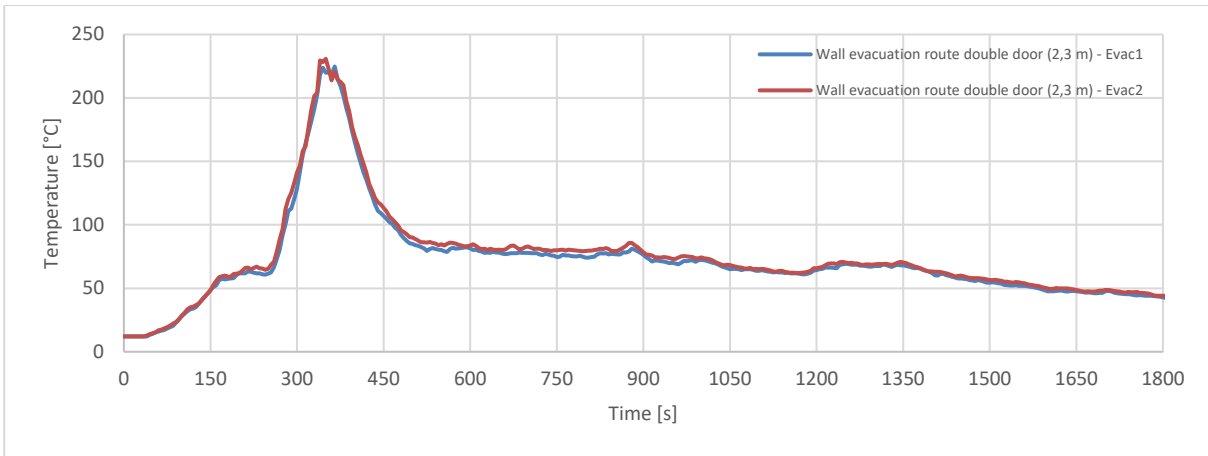

Temperatures measured at different locations in the fire room

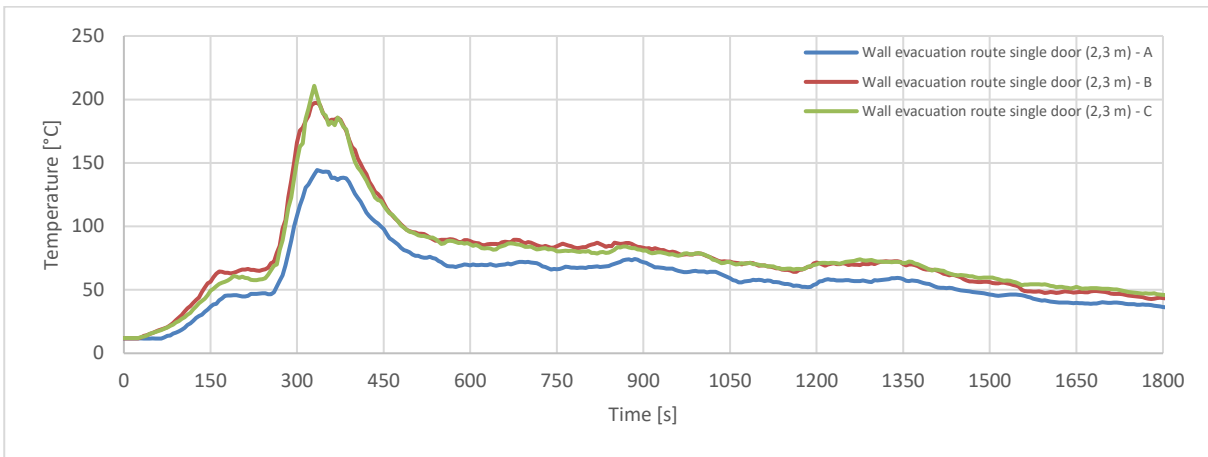

Temperatures measured at different locations in the fire room

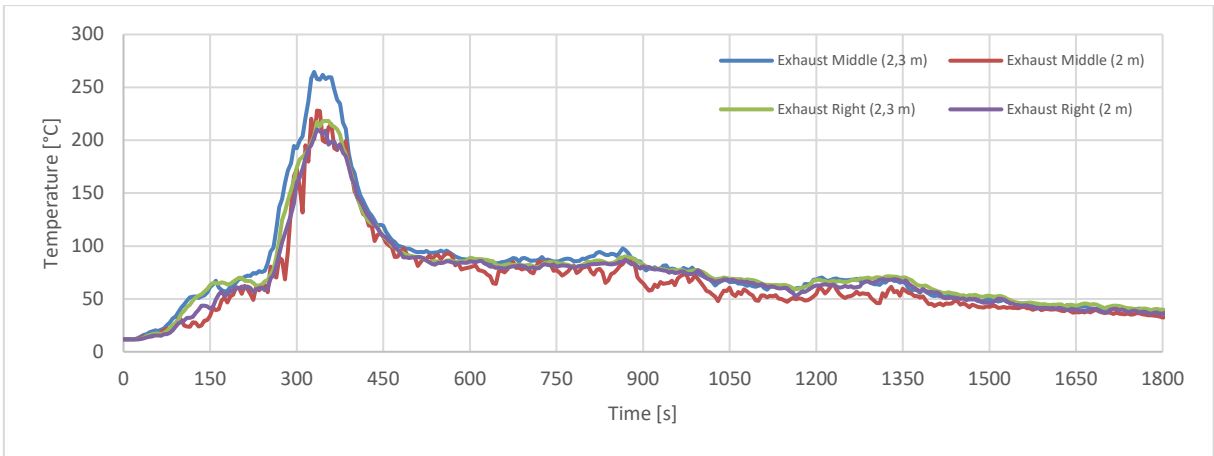

Temperatures measured in the exhaust vents of the smoke control system

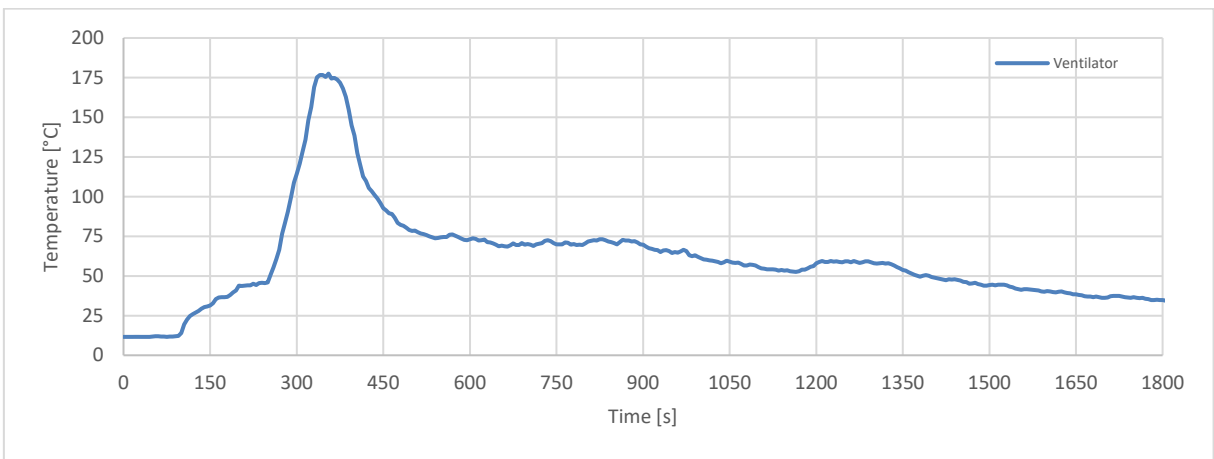

Temperatures measured in the duct of the smoke control system



CO content in the rooms and the common area (upper limit measurement: 500 ppm)

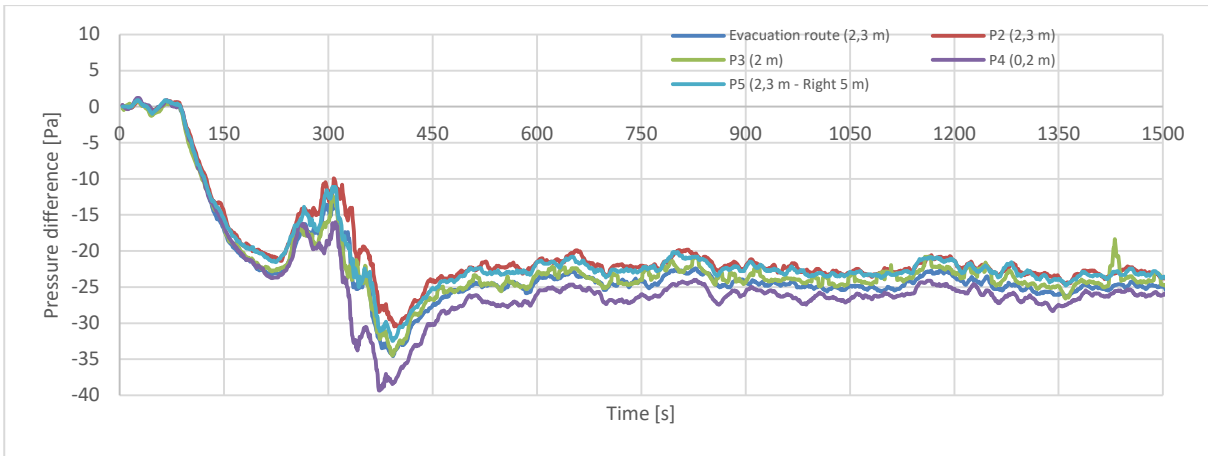

Pressure difference in the common area

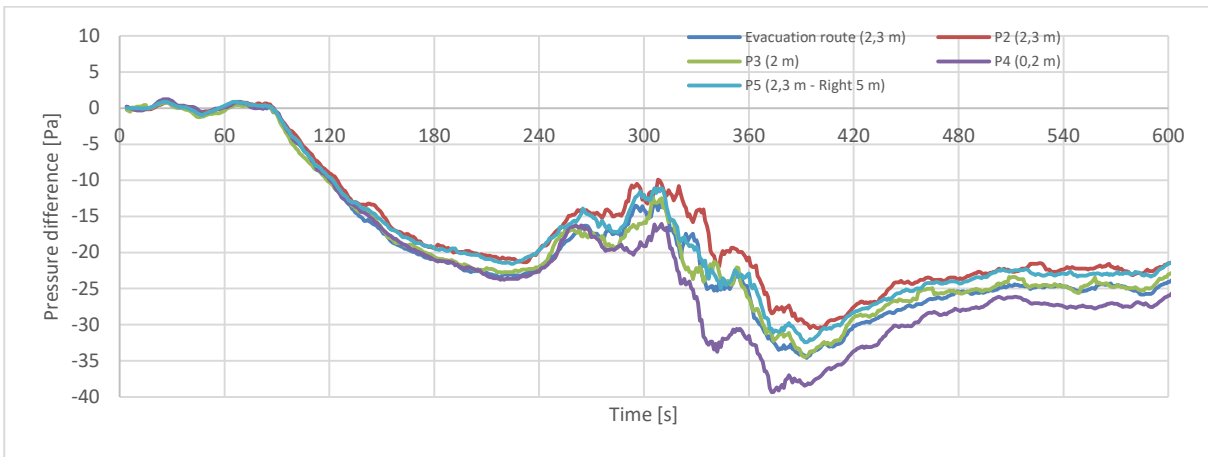

Pressure difference in the common area (first 10 minutes)

8.5 TEST 5: APPLICATION OF AUTOMATIC EXTINGUISHING

The results of the measurements (temperature, CO and pressure) are shown below:

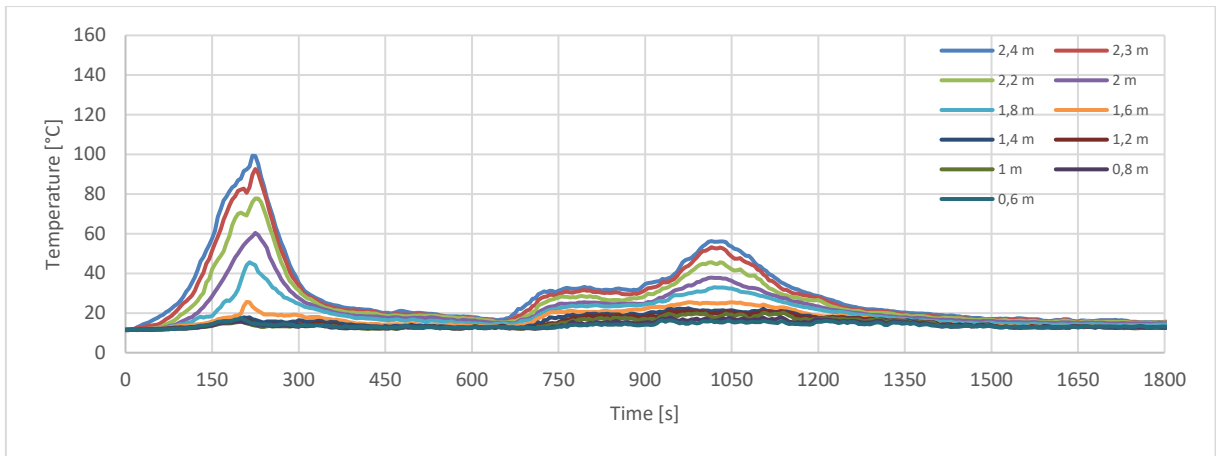

Temperatures measured in the common area (further away from the exhaust openings)

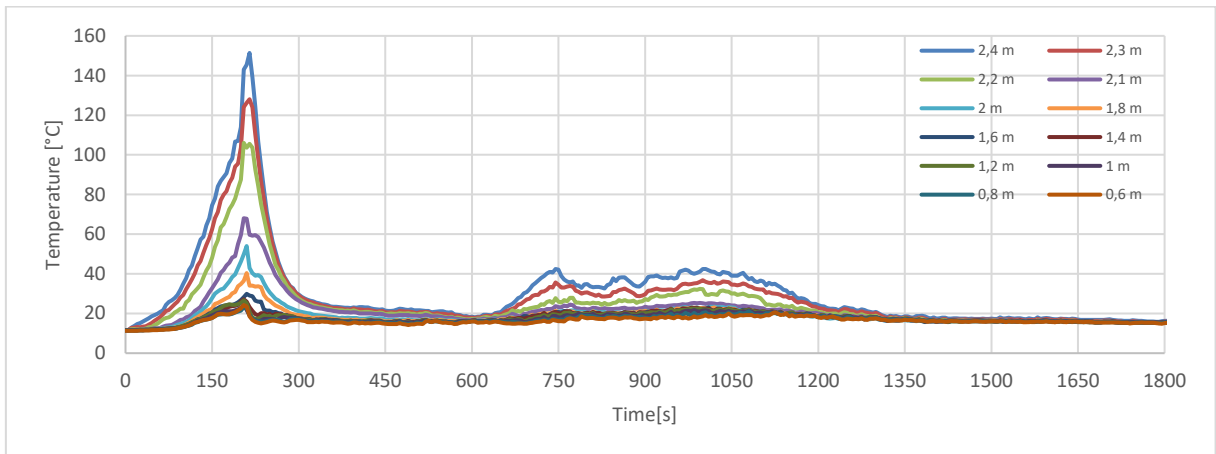

Temperatures measured in the common area (closer to the exhaust openings)

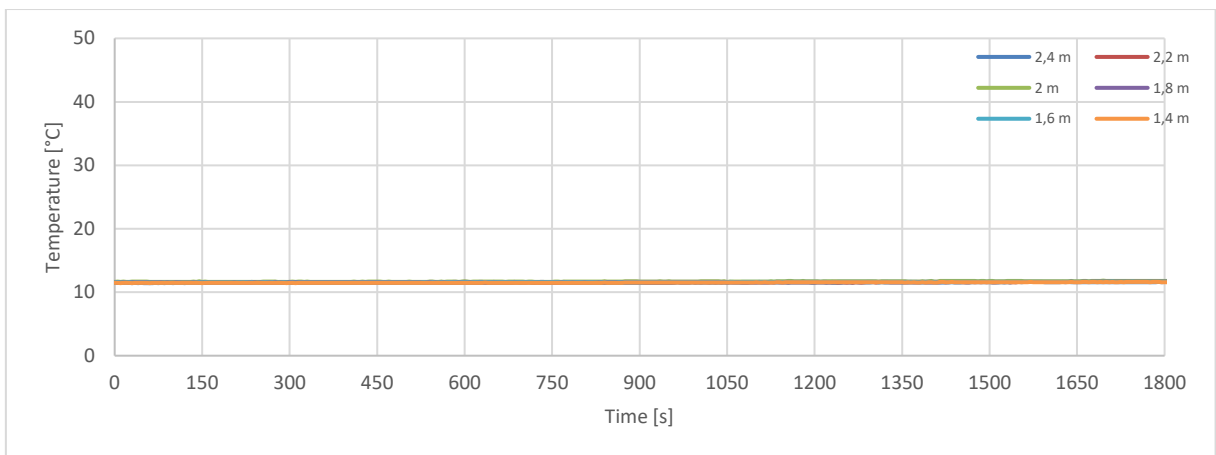

Temperatures measured in the room provided with a fire resistant door

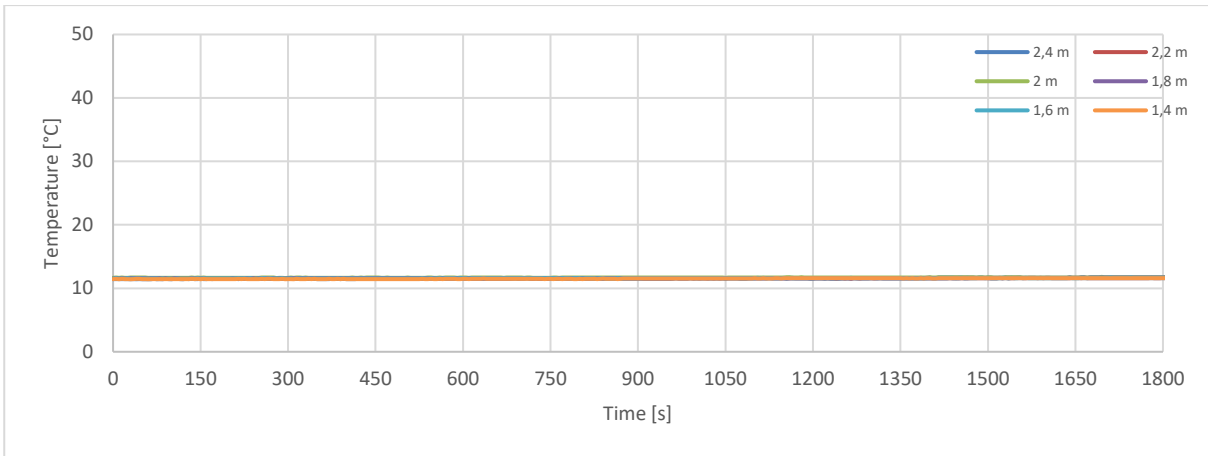

Temperatures measured in the room provided with a smoke control door

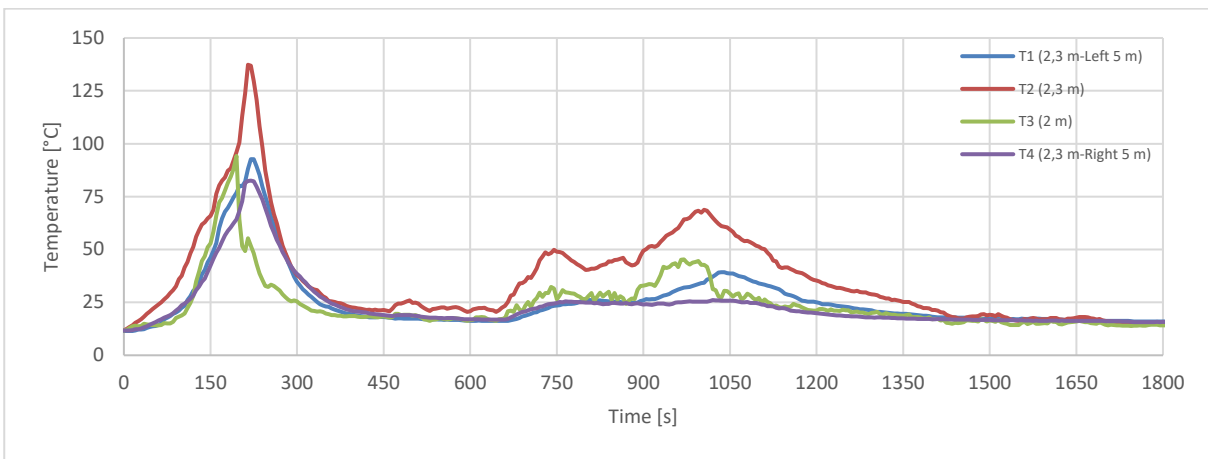

Temperatures measured on the wall directly opposite the fire source

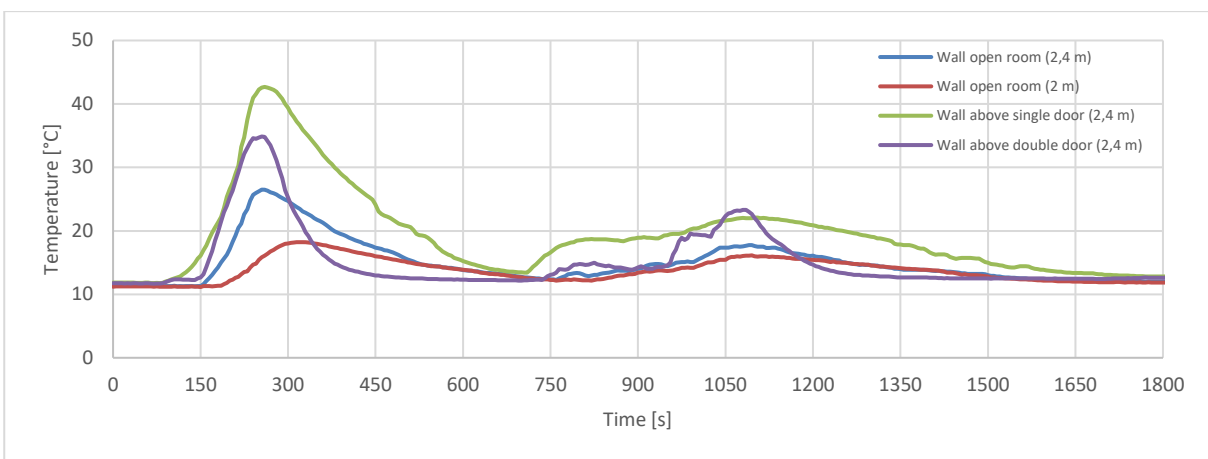

Temperatures measured at different locations in the fire room

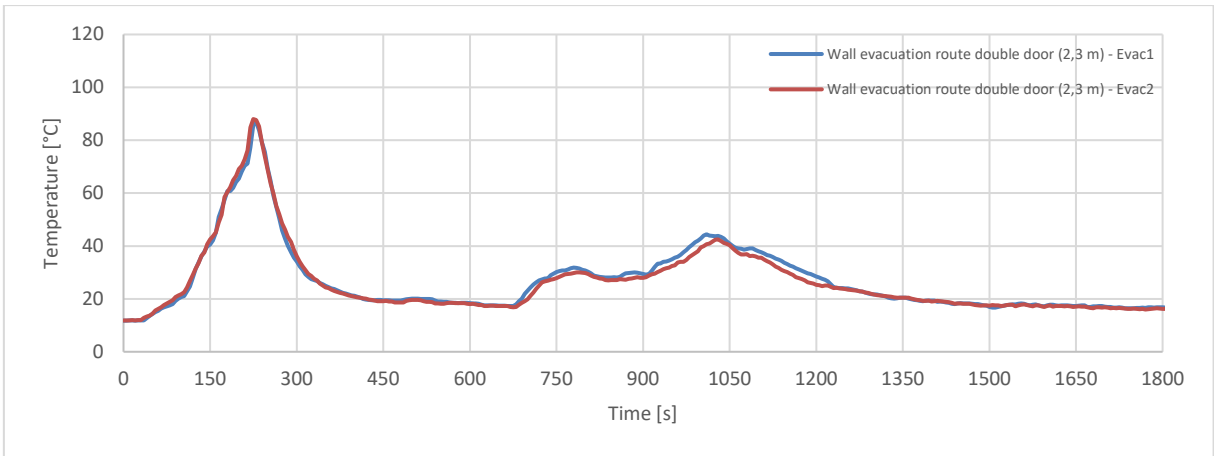

Temperatures measured at different locations in the fire room

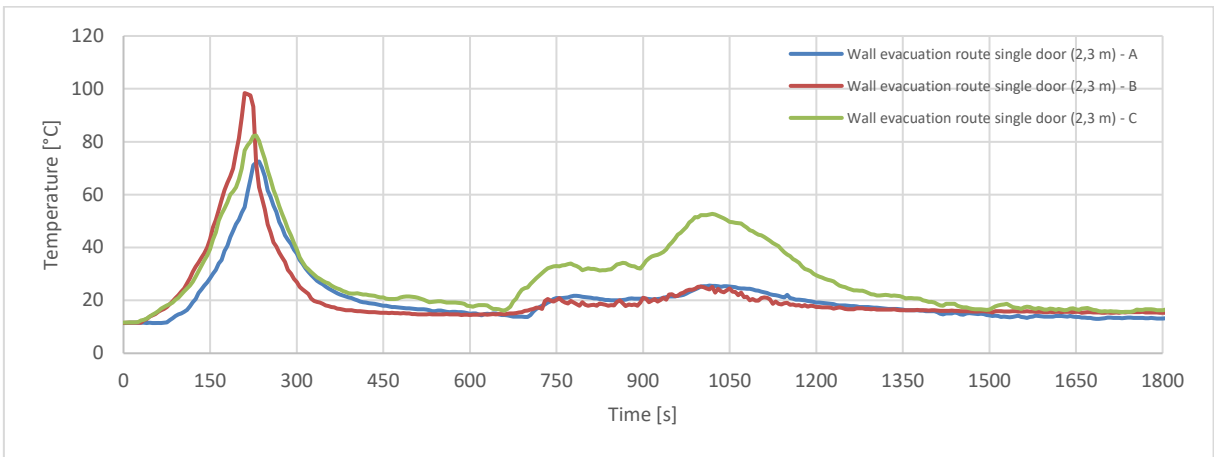

Temperatures measured at different locations in the fire room

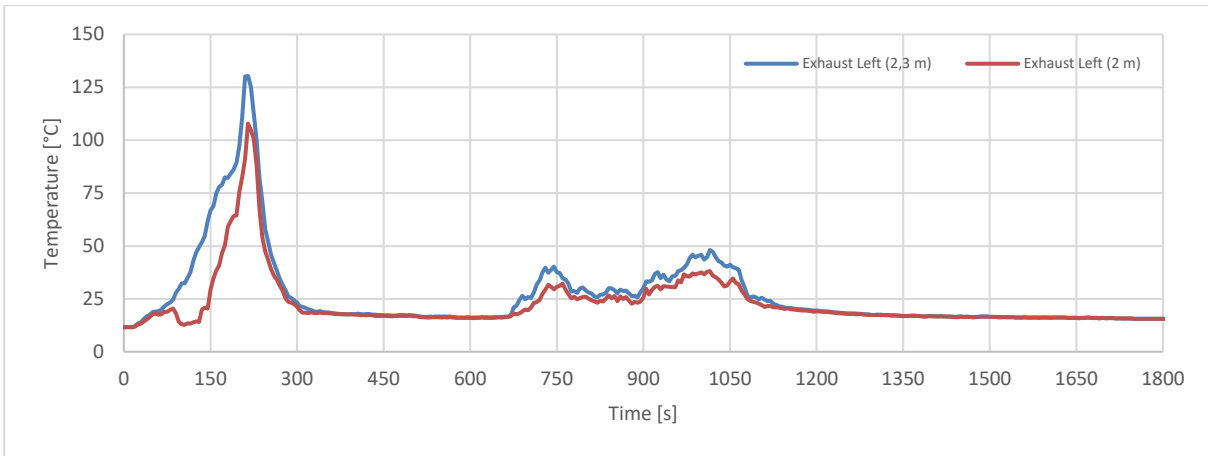

Temperatures measured in the exhaust opening of the smoke control system

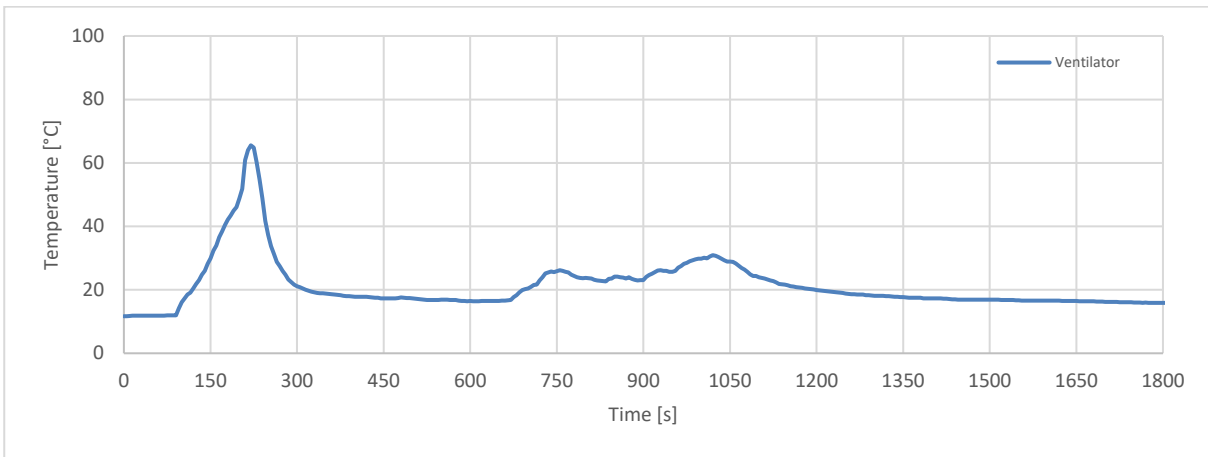

Temperatures measured in the duct of the smoke control system

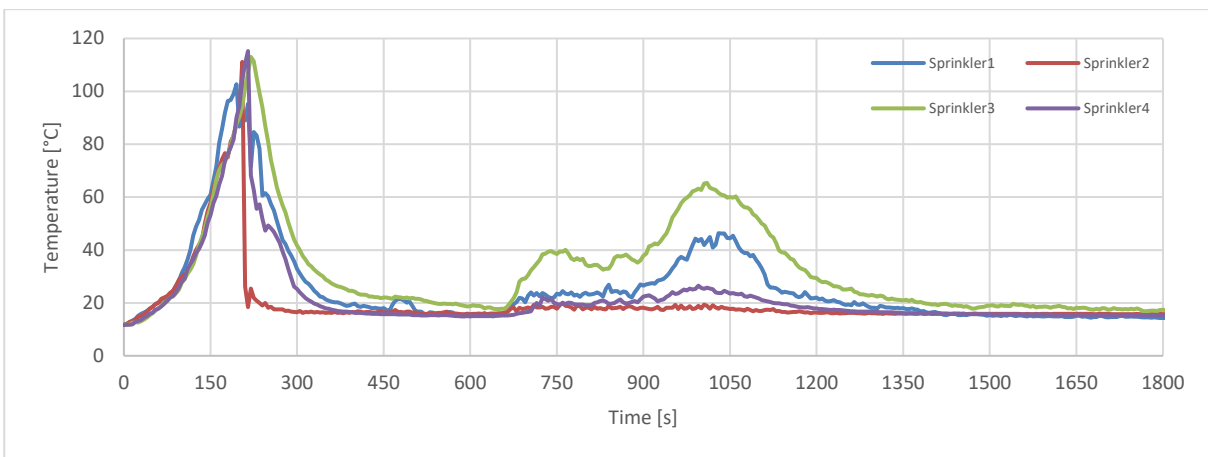

Temperatures measured at the location of the sprinklers

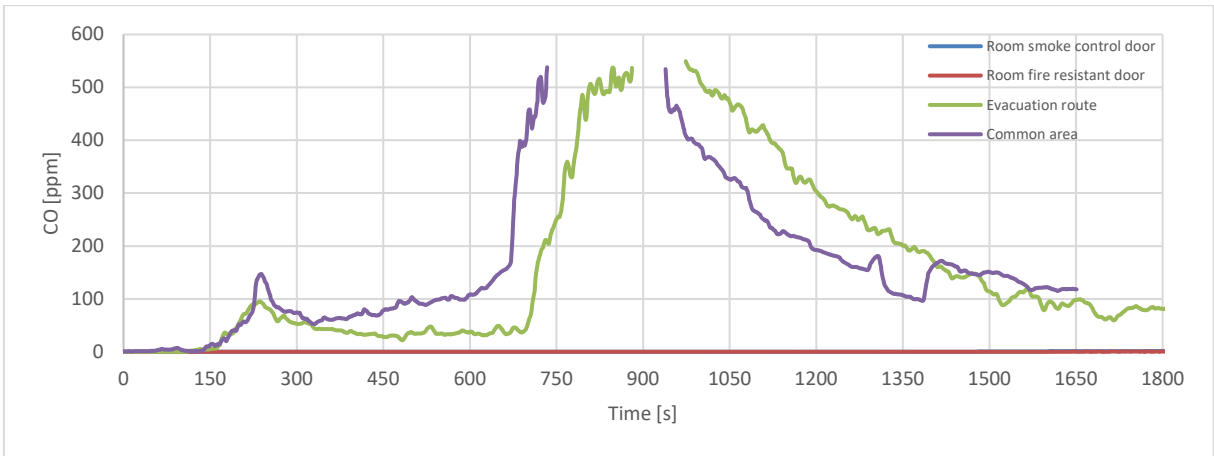

CO content in the rooms and common area (upper limit measurement: 500 ppm)

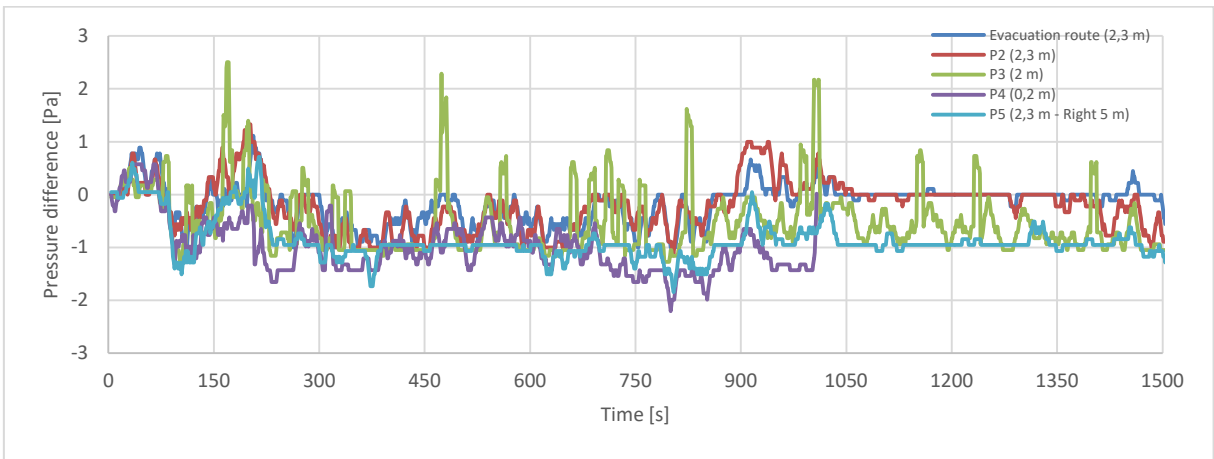

Pressure difference in the common area

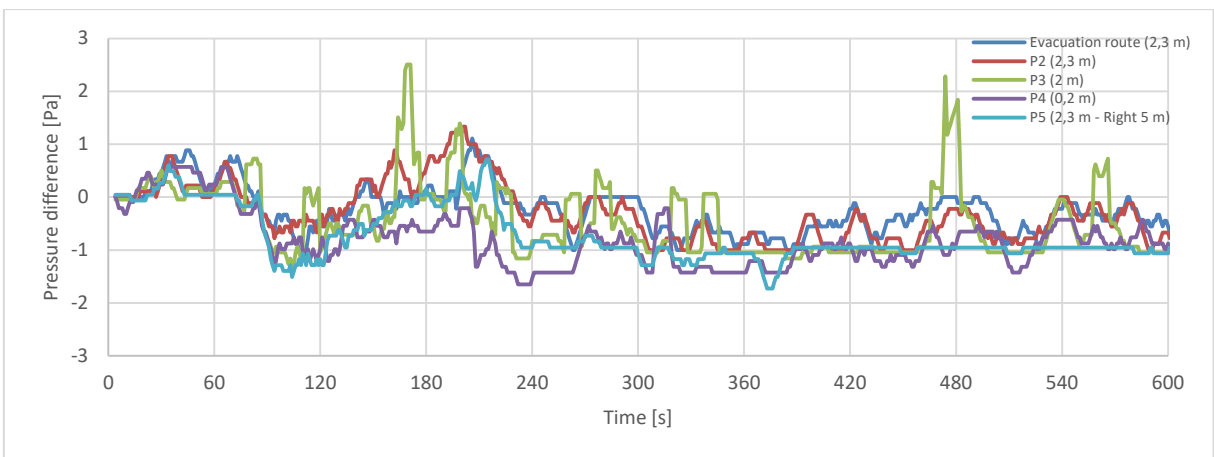

Pressure difference in the common area (first 10 minutes)